

## **activPilot**

### **SKG - Sicherheit für Kunststoffenster**

Concept / Select / Topstar

DuoPort SK

Comfort ERGO





# Allgemeine Richtlinien zur Montageanleitung activPilot (SKG) für Kunststofffenster

Allgemeine Richtlinien zur Zusammenstellung und Montage von  
Winkhaus activPilot Beschlägen für Fensterelemente  
gemäß NEN 5096 Klasse 2.

## Beschlagmontage

Die Beschlagmontage muss gemäß den Winkhaus Vorgaben erfolgen.

(Produktkataloge activPilot, Kapitel „Montageanleitung“).

Der Beschlag muss mit passenden Schrauben montiert werden .  
Sicherheitsschließbleche müssen in einer Stahlarmierung mit  
mindestens 1,5 mm oder einer Aluminiumarmierung mit min 2,0  
mm Wandstärke verschraubt werden.

## Griffolive

Der Beschlag muss mit einer SKG\*\* zertifizierten Griffolive  
ausgestattet werden.

Eine Griffolive mit Druckknopfbetätigung ist ausschließlich in  
Kombination mit einbruchhemmender Verglasung die  
mindestens der Klasse P4A nach EN 356 entspricht zulässig.

## Kennzeichnung

Wenn alle Vorschriften eingehalten wurden, muss das SKG-  
Kennzeichen an der Getriebeseite montiert werden.  
Ein einfaches Entfernen (ohne Werkzeug) darf nicht möglich  
sein.

Der Fensterhersteller bleibt zu jedem Zeitpunkt verantwortlich  
für das von ihm gelieferte Endprodukt.

Bei Fragen wenden Sie sich bitte an den Zertifikatsinhaber,  
Aug. Winkhaus GmbH & Co. KG.

## Verriegelungsabstände

Die Abstände sind zum Erreichen der, vom Systemgeber  
zugelassenen maximalen Verriegelungsabstände ggf. durch  
Hinzufügen weiterer Verschlusspunkte zu optimieren !

## Ergänzende Dokumente und Richtlinien

ergänzend zu den, in diesem Dokument beschriebenen  
Vorgaben zur Herstellung von SKG Fenstern sind die folgende  
Dokumente und Richtlinien zu berücksichtigen:

- Produktkatalog activPilot Comfort
- Produktkatalog duoPort
- allgemeine Produktinformationen activPilot
- Verarbeitungsrichtlinien des Systemgebers

# Algemene richtlijnen voor de montage van activPilot (SKG) voor kunststof ramen

Algemene richtlijnen voor de samenstelling en montage van Winkhaus activPilot-beslag voor kunststof raamelementen volgens NEN 5096 klasse 2.

## Beslagmontage

De beslagmontage dient volgens de Winkhaus opgave te geschieden.

(Productcatalogus activPilot, hoofdstuk “montagehandleiding”).

Het beslag moet met passende schroeven gemonteerd worden . Veiligheidssluitplaten moeten in het staal, met een dikte van minstens 1,5 mm of aluminium van minimaal 2,0 mm wanddikte geschroefd worden.

## Raamgreep of raamkruk

Het beslag dient met een door SKG\*\* goedgekeurde raamgreep uitgevoerd worden.

Een raamgreep met drukknopbediening is alleen toegestaan in combinatie met inbraakwerend glas dat minstens aan de klasse P4A volgens EN 356 voldoet.

## Merktken

Als alle voorschriften zijn aangehouden moet het SKG-merktken aan de sluitzijde van het raam met een niet eenvoudig verwijderbare bevestiging worden aangebracht. De ramenfabrikant blijft ten alle tijden verantwoordelijk voor het door hem geleverde eindproduct.

Voor vragen kunt u zich wenden tot de certificaathouder:  
Aug. Winkhaus GmbH & Co.KG.

## Vergrendelings- of sluitpuntafstanden

De afstanden kunnen gemaakt worden zoals door de systeemleverancier toegelaten maximale vergrendelingsafstanden of door meerdere sluitpunten aan te brengen!

## Aanvullende documenten en richtlijnen

Aanvullend op de, in dit document beschreven aanwijzingen voor het fabriceren van SKG ramen, zijn de volgende documenten en richtlijnen in acht te nemen:

- Productcatalogus activPilot Concept
- Productcatalogus activPilot Comfort
- Productcatalogus duoPort
- Algemene productinformatie activPilot Concept
- Verwerkingsrichtlijnen van de systeemprouducent

# Verschraubungen der Beschlagteile

## Schraubentabelle

Bauteile	Detail	Maß	Vorborenen $\varnothing$
Fensterrahmen*1	für Bauwerke geeignete Befestigungsmittel		
Flügelteile (Getriebebeschienen, Mittenverriegelungen, Koppelemente Eckumlenkungen, Oberschienen, Aufläufe)	Beschlagschraube (Senkkopf)	3,9 x min. 25 mm	
Rahmenteile (SBS.K..., SBK.K..., SBA.K..., Auflauf,...)	Vorkammer	Beschlagschraube 4,0 x min. 35mm	
	Stahllarmierung	Bohrschraube: 3,9 x min. 28 mm  oder Beschlagschraube 4,0 x min. 35mm	3,0 mm
Scherenlager	 Auswahl und Verarbeitung entsprechend technischer Richtlinie TBDK		
Ecklager			
Flügelager			
Griffolive	Maschinenschraube (Senkkopf)	M5 x 40	

\*1 Schrauben werden in die Stahllarmierung (Mindestwandstärke 1,5 mm) verschraubt. Schraubtlängen zur Befestigung des Flügelbeschlags und der Schließteile können der Profilsituation angepasst werden.



Die Auswahl der einzusetzenden Befestigungsschrauben erfolgt entsprechend des Flügelgewichts unter Berücksichtigung der technischen Richtlinie TBDK.

De keuze van de toe te passen bevestigingsschroeven dient te worden bepaald aan de hand van het vleugelgewicht en conform de technische richtlijnen van TBDK.

<http://www.fvsb.de/ggsb/richtlinien.asp>

## Montagepositionen der Aufläufe

### Montagehinweise Aufläufe / Falzluftbegrenzer



Bild 3:  
Position der Aufläufe bei 1-flügeligen Fenstern



Bild 3:  
Position der Aufläufe bei 2-flügeligen Fenstern

## Informativ Artikelvarianten Aufläufe

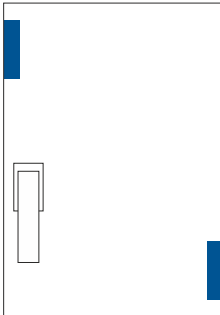
Abgestimmt auf die Montagesituation können folgende Aufläufe zum Einsatz kommen:

#### Auflauf AL.M

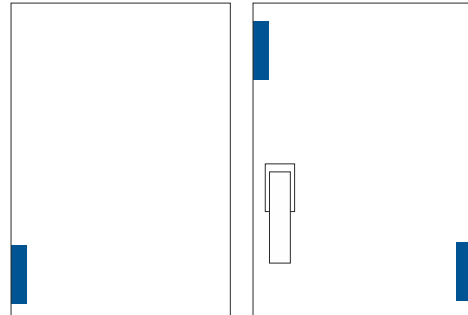
Zur Montage in der entsprechenden Lochgruppe der Mittsverriegelung  
Befestigung mit 1x Beschlagschraube 4,0 x 20

#### Auflauf AL BN

Direkte Verschraubung in der Beschlagnut  
Befestigung mit 1x Beschlagschraube 4,0 x 20

#### Flügelheber FH

Montage im Blendrahmen  
Befestigung mit 2x Beschlagschraube 4,0 x 20

#### Auflauf K.SBS

Klemmung in Sicherheitsschließblech SBS.K.xxx

#### Auflauf AL D

Montage im Blendrahmen. Durch Formteil FT.WSK an unterschiedliche Profilsysteme anpassbar  
Befestigung mit 2x Beschlagschraube 4,0 x 30

Alternative Aufläufe anderer Hersteller sind zulässig wenn:

- Die Falzluft auf max. 2,5 mm begrenzt wird
- Die Befestigung durch Verschrauben erfolgt



Bild 4:  
Position des Auflaufes, Luft zwischen Auflauf und Flügelkante (Beispiel Winkhaus AL.D)



AL.M

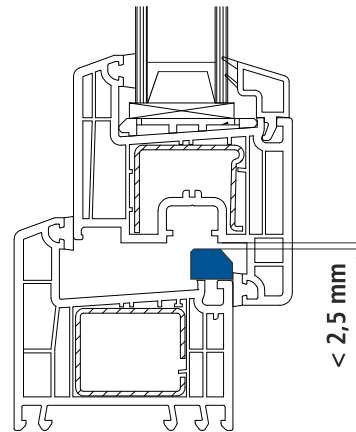
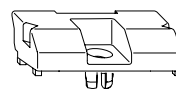
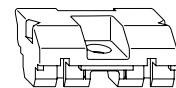

AL.BN

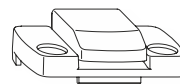

FH.152



AL.K.SBS

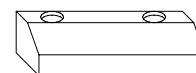

AL.D

# Sicherung der Bedienelemente

## Montage Stulpplatte SKG

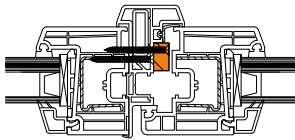

- Aluminiumblock  
120 x 18 x 10  
oder  
Aluminiumwinkel  
120 x 20 x 10 x 3mm

Befestigung mit  
3 Schrauben  
4,0 x 35 mm

oder

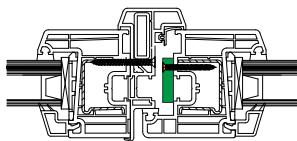

- Stulpniederhalter SNH.AGR  
Montage erfolgt auf DK Seite  
gegenüber dem Stulpbedienhebel  
Befestigung mit  
2 Schrauben  
4,0 x 25 mm

Getriebe GASM + GASK



Getriebe GAM + GAK

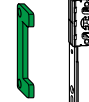



# Beschlagübersichten

## Erklärung zur Beschlagmatrix

Oberseite  
Beschlagteile  
Anwendungsbereiche

Concept **innenöffnend, mittiger Griff Sitz**  
**211121 Drehkippenfenster**  
**211721 Drehfenster mit AWDR**

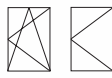

FFB	350 - 370	371 - 600	601 - 800	801 - 1025	1026 - 1250	1251 - 1475	1476 - 1725	V800
FFH	OS1.600	OS1.600	OS2.800	OS2.1025-1	OS2.1250-1	OS2.1475-1	OS2.1475-1 +ZS+FT	
325 - 510 GAM.800		B:H 4	B:H 4	B:H 5	B:H 5	B:H 5	B:H 6	
511 - 710 GAM.800				B:H 5	B:H 5	B:H 5	B:H 6	
711 - 980 GAM.1050-1				B:H 5	B:H 5	B:H 5	B:H 6	711 - 980 M.500-1
981 - 1300 GAM.1400-1							B:H 6	981 - 1300 M.500-1
1301 - 1400 GAM.1400-1							>2,5m <sup>2</sup> 8	1301 - 1400 M.750-1
1401 - 1800 GAM.1800-2						>2,5m <sup>2</sup> 8	>2,5m <sup>2</sup> 9	1401 - 1800 MK.500-1 M.500-1
1801 - 2300 GAM.2300-3 (2x SBS)			> ,5m <sup>2</sup> 8	>2,5m <sup>2</sup> 9	>2,5m <sup>2</sup> 9	>2,5m <sup>2</sup> 9	>2,5m <sup>2</sup> 10	1801 - 2300 MK.500-1 MK.500-1 M.500-1
für Verriegelungsabstände 700 mm Anhang berücksichtigen !								
	350 - 370 M.250-1	371 - 600 M.250-1	601 - 800 M.500-1	801 - 1025 M.500-1	1026 - 1250 M.750-1	1251 - 1475 MK.500-1 M.500-1	1475 - 1725 MK.500-1 M.750-1	

Getriebeseite  
Beschlagteile  
Anwendungsbereiche

Bandseite  
Beschlagteile  
Anwendungsbereiche

Anzahl der  
Sicherheits-  
verriegelungen

Unterseite  
Beschlagteile  
Anwendungsbereiche

**Kennzeichnung Produkthaftung**



- Einhaltung der Produkthaftung prüfen !  
(B:H > 2:1 , Fläche >2,5m<sup>2</sup>)
- Größe liegt außerhalb der Produkthaftung  
(B:H > 2:1 , Fläche >2,5m<sup>2</sup>)

Für Details ist die Hinweise zur Produkthaftung aus den Produktkatalogen unbedingt hinzuzuziehen !



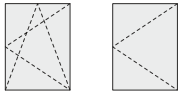

# activPilot Concept Dreh- /Drehkippfenster innenöffnend

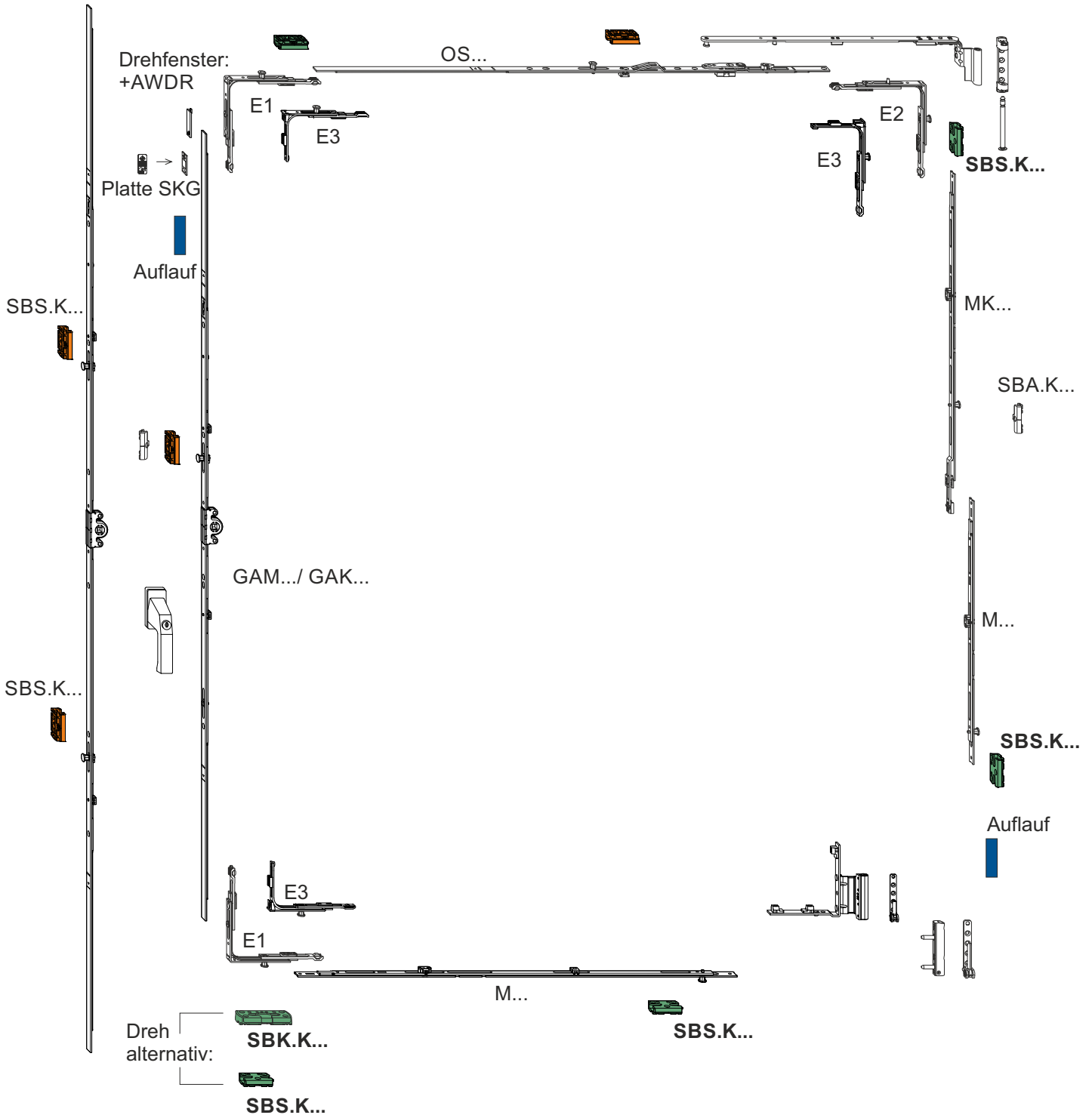

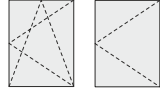

**activPilot Concept**  
**Drehkippenfenster**  
**Drehfenster mit AWDR**  
**innenöffnend, mittlerer Griffsitz**

**211121**  
**211721**

FFB / FFH	350 - 370 OS1.600	371 - 600 OS1.600	601 - 800 OS2.800	801 - 1025 OS2.1025-1	1026 - 1250 OS2.1250-1	1251 - 1475 OS2.1475-1	1476 - 1725 OS2.1475-1 +ZS+FT	V800* 
<b>325 - 510</b> GAM.800	X		B:H 4	B:H 4	B:H 5	B:H 5	B:H 5	B:H 6
<b>511 - 710</b> GAM.800	4	4	4	B:H 5	B:H 5	B:H 5	B:H 6	
<b>711 - 980</b> GAM.1050-1	4	4	4	5	B:H 5	B:H 5	B:H 6	<b>861 - 980</b> M.500-1
<b>981 - 1300</b> GAM.1400-1	4	4	4	5	5	5	B:H 6	<b>981 - 1285</b> M.500-1
<b>1301 - 1400</b> GAM.1400-1	6 <sup>†</sup>	6 <sup>†</sup>	6 <sup>†</sup>	7 <sup>†</sup>	7 <sup>†</sup>	7 <sup>†</sup>	>2,5m <sup>2</sup> 8 <sup>†</sup>	<b>1286 - 1535</b> M.750-1
<b>1401 - 1800</b> GAM.1800-2	7 <sup>†</sup>	7 <sup>†</sup>	7 <sup>†</sup>	8 <sup>†</sup>	8 <sup>†</sup>	>2,5m <sup>2</sup> 8 <sup>†</sup>	>2,5m <sup>2</sup> 9 <sup>†</sup>	<b>1536 - 1785</b> MK.500-1 M.500-1
<b>1801 - 2300</b> GAM.2300-3 (2x SBS)	8 <sup>†</sup>	8 <sup>†</sup>	>,5m <sup>2</sup> 8 <sup>†</sup>	>2,5m <sup>2</sup> 9 <sup>†</sup>	>2,5m <sup>2</sup> 9 <sup>†</sup>	>2,5m <sup>2</sup> 9 <sup>†</sup>	>2,5m <sup>2</sup> 10 <sup>†</sup>	<b>1786 - 2035</b> MK.750-1 M.500-1 <b>2036 - 2300</b> MK.750-1 M.750-1
			*für Verriegelungsabstände 700 mm Anhang berücksichtigen !					
	<b>350 - 430</b> M.250-1	<b>431 - 630</b> M.250-1	<b>631 - 800</b> M.500-1	<b>801 - 1025</b> M.500-1	<b>1026 - 1250</b> M.750-1	<b>1251 - 1475</b> MK.500-1 M.500-1	<b>1475 - 1725</b> MK.500-1 M.750-1	

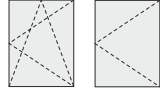

**activPilot Concept**  
**Drehkipfenster**  
**Drehfenster mit AWDR**

**211111**  
**211711**

**innenöffnend, konstanter Griffsitz**

FFB / FFH	350 - 370	371 - 600	601 - 800	801 - 1025	1026 - 1250	1251 - 1475	1476 - 1725	V800*
	OS1.600	OS1.600	OS2.800	OS2.1025-1	OS2.1250-1	OS2.1475-1	OS2.1475-1 +ZS+FT	
<b>230 - 325</b> GAK.465								
<b>326 - 420</b> GAK.465								
<b>421 - 460</b> GAK.465								
<b>461 - 700</b> GAK.710								
<b>701 - 850</b> GAK.945-1								
<b>851 - 1100</b> GAK.1100-1								<b>861 - 980</b> M.500-1
<b>1100 - 1325</b> GAK.1325-1								<b>981 - 1285</b> M.500-1
<b>1326 - 1550</b> GAK.1550-1								<b>1286 - 1535</b> M.750-1
<b>1551 - 1775</b> GAK.1775-2								<b>1536 - 1785</b> MK.500-1 M.500-1
<b>1776 - 2000</b> GAK.2000-2								<b>1786 - 2035</b> MK.750-1 M.500-1
<b>2001 - 2225</b> GAK.2225-2								<b>2036 - 2300</b> MK.750-1 M.750-1
	<b>350 - 370</b> M.250-1 	<b>371 - 630</b> M.250-1 	<b>631 - 800</b> M.500-1	<b>801 - 1025</b> M.500-1	<b>1026 - 1250</b> M.750-1	<b>1251 - 1475</b> MK.500-1 M.500-1	<b>1475 - 1725</b> MK.500-1 M.750-1	



# Rahmenteilpositionen Maßbezüge DK Fenster

## Mittiger Griffsitz GAM...

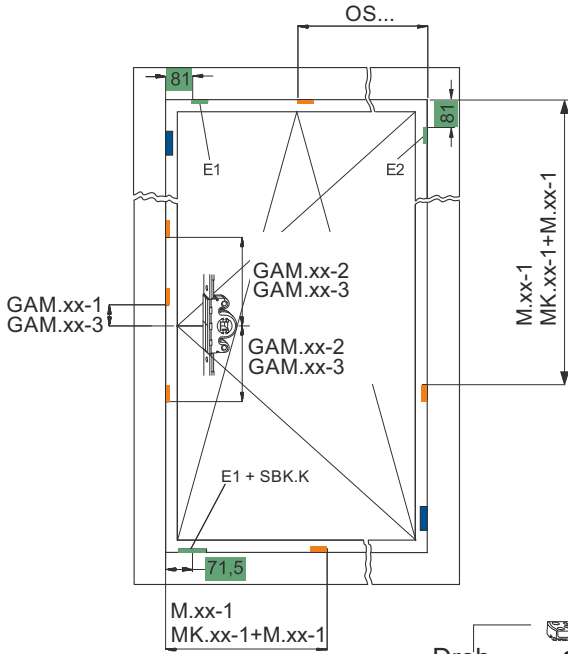

## Konstanter Griffsitz GAK...

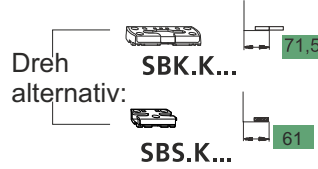
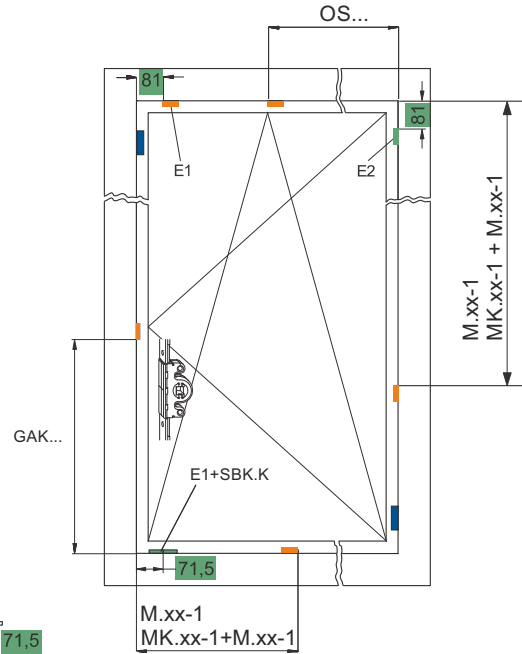

## Maßbezug Sicherheitsschließteil SBS.K

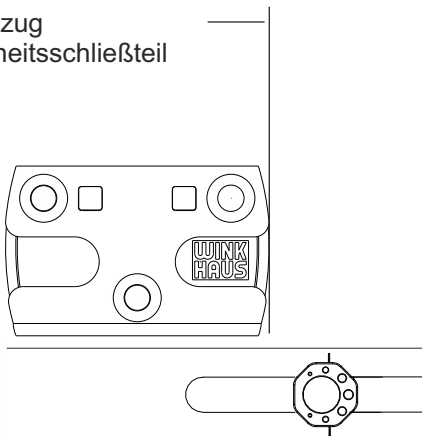

## Maßbezug Sicherheitskippschließblech SBS.K

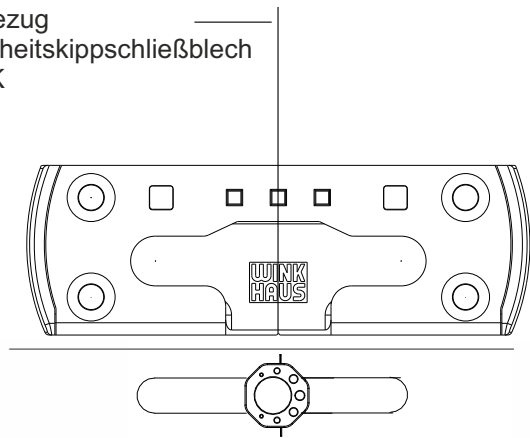

# Rahmenteilpositionen Getriebe

## Verriegelungsabstand 800 mm

### konstanter Griffsitz 1 flg

FFH min/max	Getriebe		SB Positionen
230 - 460	GA..K.465		--
461 - 700	GA..K.710		--
701 - 850	GA..K.945-1		385
851 - 1100	GA..K.1100-1		500
1101 - 1325	GA..K.1325-1		750
1326 - 1550	GA..K.1550-1	1	<b>750</b>
1550 - 1775	GA..K.1775-2	2	<b>750 1250</b>
1776 - 2000	GA..K.2000-2	2	<b>750 1250</b>
2001 - 2225	GA..K.2225-2	2	<b>750 1500</b>



### mittiger Griffsitz 1 flg

FFH min/max	Getriebe		SB Positionen
326 - 800	GA..M 800		--
800 - 1050	GA..M.1050-1		127
1051 - 1300	GA..M.1400-1		127
1301 - 1400	GA..M.1400-1	1	<b>127</b>
1401 - 1800	GA..M.1800-2	2	<b>-340 260</b>
1801 - 2300	GA..M.2300-3	2	<b>-520 127 692</b>



## Verriegelungsabstand 700 mm

### konstanter Griffsitz

FFH min/max	Getriebe		SB Positionen
230 - 460	GA..K.465		--
461 - 700	GA..K.710		--
701 - 850	GA..K.945-1		385
851 - 1100	GA..K.1100-1		500
1101 - 1325	GA..K.1325-2		385 750
1326 - 1550	GA..K.1550-2	1	385 <b>1000</b>
1551 - 1775	GA..K.1775-3	2	385 <b>750 1250</b>
1776 - 2000	GA..K.2000-4	2	385 <b>750 1250</b> 1500
2001 - 2225	GA..K.2225-4	2	385 <b>750 1250 1750</b>



### mittiger Griffsitz

FFH min/max	Getriebe		SB Positionen
325 - 800	GA..M 800		--
800 - 1050	GA..M.1050-1		127
1051 - 1300	GA..M.1400-2		-223 127
1301 - 1400	GA..M.1400-2	1	-223 <b>127</b>
1401 - 1800	GA..M.1800-2	2	<b>-340 260</b>
1801 - 2300	GA..M..2300-3	2	<b>-520 127 692</b>





# Rahmenteilpositionen Mittenverriegelungen unten Oberschiene

## Bandseite Verriegelungsabstand 800 mm



### konstanter + mittiger Griffsitz

FFH min/max	M../MK..		SB Positionen.	
861 - 1285	M.500-1		500	
1286 - 1535	M.750-1	1	750	
1536 - 1785	MK.500-1 + M.500-1	1	500	1000
1786 - 2035	MK.750-1 + M.500-1	1	750	1250
2036 - 2285	MK.750-1 + MK.750-1	2	750	1500

## Bandseite Verriegelungsabstand 700 mm

### konstanter + mittiger Griffsitz

FFH min/max	M../MK..		SB Positionen		
760 - 1185	M.500-1		500		
1186 - 1435	M.750-1	1	750		
1436 - 1685	MK.500-1 + M.500-1	1	500	1000	
1686 - 1935	MK.750-1 + M.500-1	1	750	1250	
1936 - 2185	MK.500-1 + MK.500-1 + M.500-1	1	500	1000	1500
2185 - 2300	MK.750-1 + MK.500-1 + M.500-1	2	750	1000	1500

## unten Verriegelungsabstand 700 + 800 mm



FFB min/max	M../MK..		SB Positionen.		
270 - 630	M.250-1	1	230		
631 - 1025	M.500-1	1	480		
1026 - 1250	M.750-1	1	730		
1251 - 1475	MK.500-1 + M.500-1	1	480	980	
1476 - 1725	MK.750-1 + M.500-1	1	730	1230	

## Oberschiene Verriegelungsabstand 700 mm



FFB min/max	M../MK..		SB Positionen.		
270 - 600	OS1.600		-		
601 - 800	OS2.800		-		
776 - 1025	OS2.1025-1	1	480		
1026 - 1275	OS2.1025-1 + MK.250-1	1	480		
1276 - 1475	OS2.1025-1 + MK.500-1	1	480		
1476 - 1525	OS2.1025-1 + MK.250-1+ZSR	2	480	250 (von Griffseite)	
1526 - 1725	OS2.1025-1 + MK.500-1+ZSR	2	480	500 (von Griffseite)	

## Oberschiene Verriegelungsabstand 800 mm

FFB min/max	M../MK..		SB Positionen.		
270 - 600	OS1.600	-	-		
601 - 800	OS2.800	-	-		
801 - 1025	OS2.1025-1	1	480		
1026 - 1250	OS2.1250-1	1	480		
1251 - 1725	OS2.1475-1 (+ZSR)	1	730		





# activPilot Concept Stulpfenster

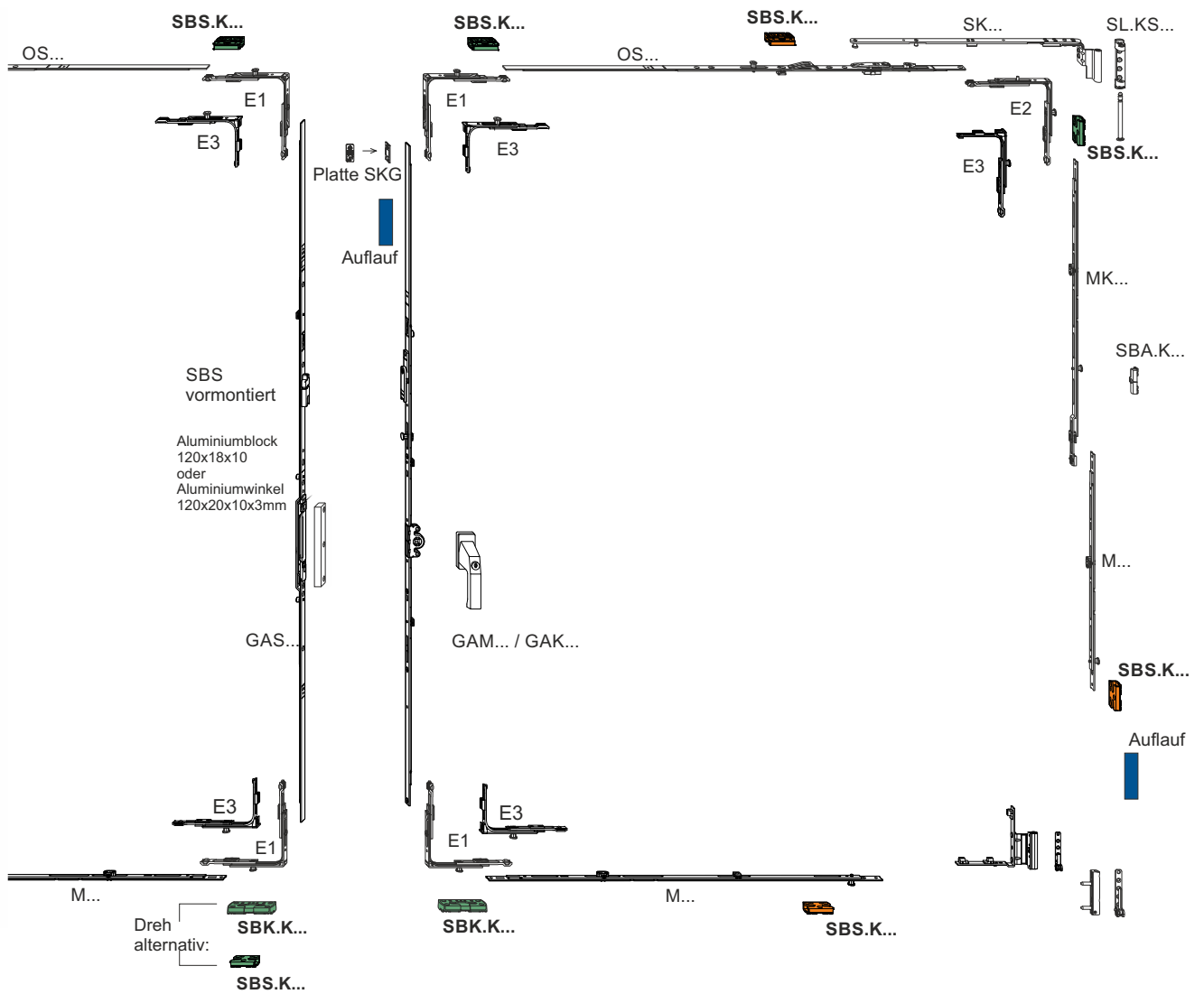



**activPilot Concept**  
**Stulpfenster, erstöffnender Flügel**  
**Drehkipp**  
**innenöffnend, mittiger Griffsitz**



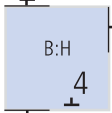
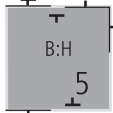
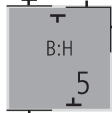
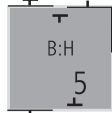
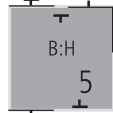
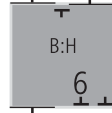
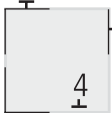
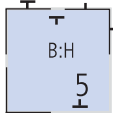
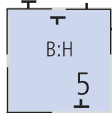
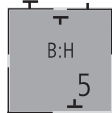
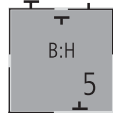
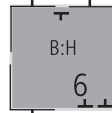
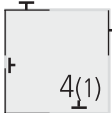
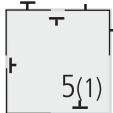
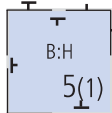
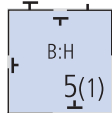
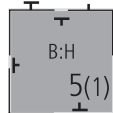
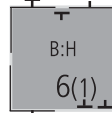
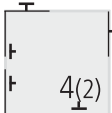
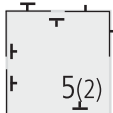
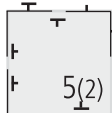
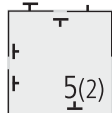
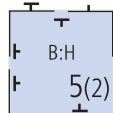
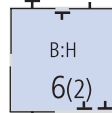
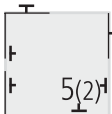
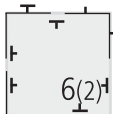
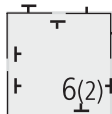
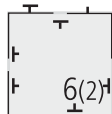
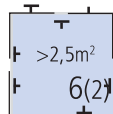
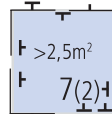
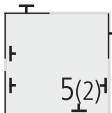
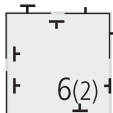
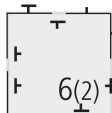
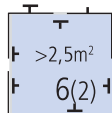
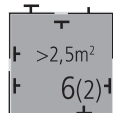
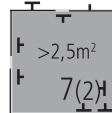
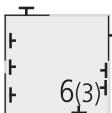
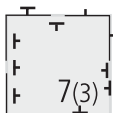
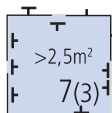
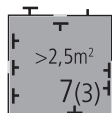
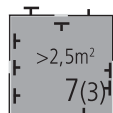
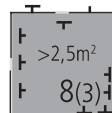
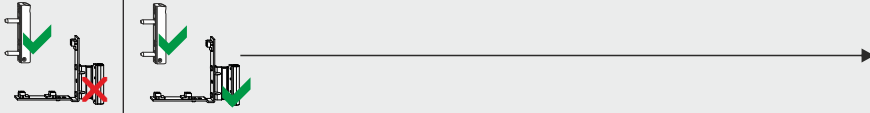
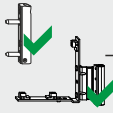

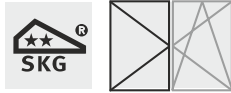



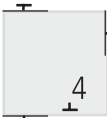
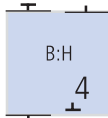
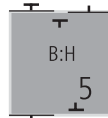
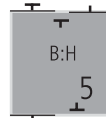
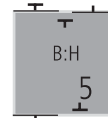
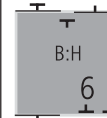
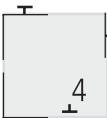
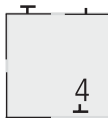
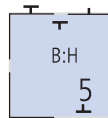
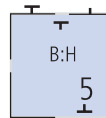
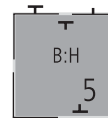
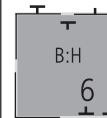
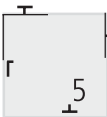
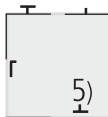
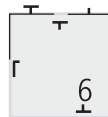
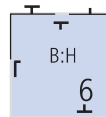
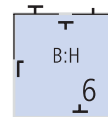
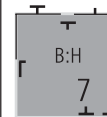

**211221**

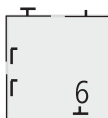
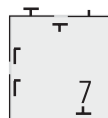
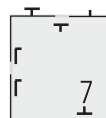
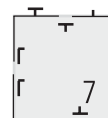
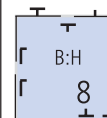
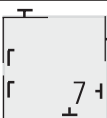
FFB \ FFH	370 - 600 OS1.600	601 - 800 OS2.800	801 - 1025 OS2.1025-1	1026 - 1250 OS2.1250-1	1251 - 1475 OS2.1475-1	1476 - 1725 OS2.1475-1 +ZS+FT		V800* 
<b>410 - 560</b> GAM.800								
<b>561 - 710</b> GAM.800								
<b>711 - 980</b> GAM.1050-1							<b>861 - 980</b> M.500-1	
<b>981 - 1300</b> GAM.1400-2							<b>981 - 1285</b> M.500-1	
<b>1301 - 1400</b> GAM.1400-2							<b>1286 - 1535</b> M.750-1	
<b>1401 - 1800</b> GAM.1800-2							<b>1536 - 1785</b> MK.500-1 M.500-1	
<b>1801 - 2300</b> GAM.2300-3							<b>1786 - 2035</b> MK.750-1 M.500-1 <b>2036 - 2300</b> MK.750-1 M.750-1	
			* Verriegelungsabstand <b>700 mm</b> siehe Rahmenteilpositionen !					
	<b>350 - 430</b> M.250-1	<b>431 - 630</b> M.250-1	<b>631 - 800</b> M.500-1	<b>801 - 1025</b> M.500-1	<b>1026 - 1250</b> M.750-1	<b>1251 - 1475</b> MK.500-1 M.500-1	<b>1475 - 1725</b> MK.500-1 M.750-1	
					→			

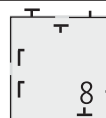
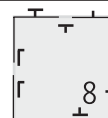
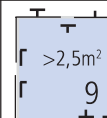
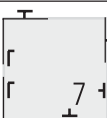
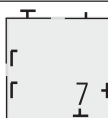

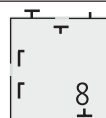
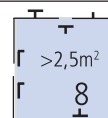
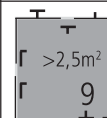
**activPilot Concept**  
**Stulpfenster, zweitöffnender Flügel**  
**Dreh**  
**innenöffnend, mittiger Griffsitz**

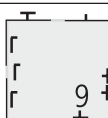
**211221**

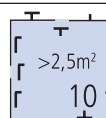
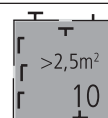
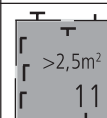
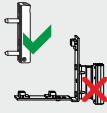
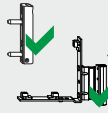
FFB \ FFH	370 - 600 OS1.600	601 - 800 OS2.800	801 - 1025 OS2.1025-1	1026 - 1250 OS2.1250-1	1251 - 1475 OS2.1475-1	1476 - 1725 OS2.1475-1 +ZS+FT		V800* 
<b>410 - 560</b> GASM.800								
<b>561 - 710</b> GASM.800								
<b>711 - 980</b> GASM.1050-1								<b>861 - 980</b> M.500-1
<b>981 - 1300</b> GASM.1400-2								<b>981 - 1285</b> M.500-1
<b>1301 - 1400</b> GASM.1400-2								<b>1286 - 1535</b> M.750-1
<b>1401 - 1800</b> GASM.1800-2								<b>1536 - 1785</b> MK.500-1 M.500-1
<b>1801 - 2300</b> GASM.2300-3								<b>1786 - 2035</b> MK.750-1 M.500-1 <b>2036 - 2300</b> MK.750-1 M.750-1
			*Verriegelungsabstand <b>700 mm</b> siehe Rahmenteilpositionen					
	<b>350 - 430</b> M.250-1	<b>431 - 630</b> M.250-1	<b>631 - 800</b> M.500-1	<b>801 - 1025</b> M.500-1	<b>1026 - 1250</b> M.750-1	<b>1251 - 1475</b> MK.500-1 M.500-1	<b>1475 - 1725</b> MK.500-1 M.750-1	
					→			

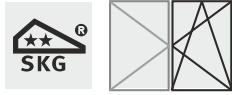

**activPilot Concept**  
**Stulpfenster, erstöffnender Flügel**  
**Drehkipp**  
**innenöffnend, konstanter Griffsitz**

# 211211

FFB / FFH	370 - 600 OS1.600	601 - 800 OS2.800	801 - 1025 OS2.1025-1	1026 - 1250 OS2.1250-1	1251 - 1475 OS2.1475-1	1476 - 1725 OS2.1475-1 +ZS+FT	V800*
<b>450 - 460</b> GAK.465							
<b>461 700</b> GAK.710							
<b>701 - 850</b> GAK.945-1							
<b>851 - 1100</b> GAK.1100-1							<b>861 - 980</b> M.500-1
<b>1101 - 1325</b> GAK.1325-2							<b>981 - 1285</b> M.500-1
<b>1326 - 1550</b> GAK.1550-2							<b>1286 - 1535</b> M.750-1
<b>1551 - 1775</b> GAK.1775-2							<b>1536 - 1785</b> MK.500-1 M.500-1
<b>1776 - 2000</b> GAK.2000-2							<b>1786 - 2035</b> MK.750-1 M.500-1
<b>2001 - 2225</b> GAK.2225-2							<b>2036 - 2300</b> MK.750-1 M.750-1
			*Verriegelungsabstand <b>700 mm</b> siehe Rahmenteilpositionen				
	<b>350 - 430</b> M.250-1	<b>431 - 630</b> M.250-1	<b>631 - 800</b> M.500-1	<b>801 - 1025</b> M.500-1	<b>1026 - 1250</b> M.750-1	<b>1251 - 1475</b> MK.500-1 M.500-1	<b>1475 - 1725</b> MK.500-1 M.750-1

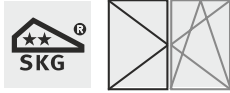

**activPilot Concept**  
**Stulpfenster, zweiföffnender Flügel**  
**Dreh**  
**innenöffnend, konstanter Griffsitz**

**211211**

FFB / FFH	370 - 600	601 - 800	801 - 1025	1026 - 1250	1251 - 1475	1476 - 1725		V800*	
	OS1.600	OS2.800	OS2.1025-1	OS2.1250-1	OS2.1475-1	OS2.1475-1 +ZS+FT			
<b>450 - 460</b> GASK.710		B:H 	B:H 	B:H 	B:H 	B:H 			
<b>461 - 700</b> GASK.710			B:H 	B:H 	B:H 	B:H 			
<b>701 - 850</b> GASK.945-1				B:H 	B:H 	B:H 			
<b>851 - 1100</b> GASK.1100-1					B:H 	B:H 	<b>861 - 980</b> M.500-1		
<b>1101 - 1325</b> GASK.1325-2						B:H 	<b>981 - 1285</b> M.500-1		
<b>1326 - 1550</b> GASK.1550-2							<b>1286 - 1535</b> M.750-1		
<b>1551 - 1775</b> GASK.1775-2						 >2,5m <sup>2</sup>	<b>1536 - 1785</b> MK.500-1 M.500-1		
<b>1776 - 2000</b> GASK.2000-2					 >2,5m <sup>2</sup>	 >2,5m <sup>2</sup>	<b>1786 - 2035</b> MK.750-1 M.500-1		
<b>2001 - 2225</b> GASK.2225-2				 >2,5m <sup>2</sup>	 >2,5m <sup>2</sup>	 >2,5m <sup>2</sup>	<b>2036 - 2300</b> MK.750-1 M.750-1		
			* Verriegelungsabstand <b>700 mm</b> siehe Rahmenteilpositionen!						
	<b>350 - 430</b> M.250-1	<b>431 - 630</b> M.250-1	<b>631 - 800</b> M.500-1	<b>801 - 1025</b> M.500-1	<b>1026 - 1250</b> M.750-1	<b>1251 - 1475</b> MK.500-1 M.500-1	<b>1475 - 1725</b> MK.500-1 M.750-1		





# Rahmenteilpositionen Maßbezüge Stulpfenster

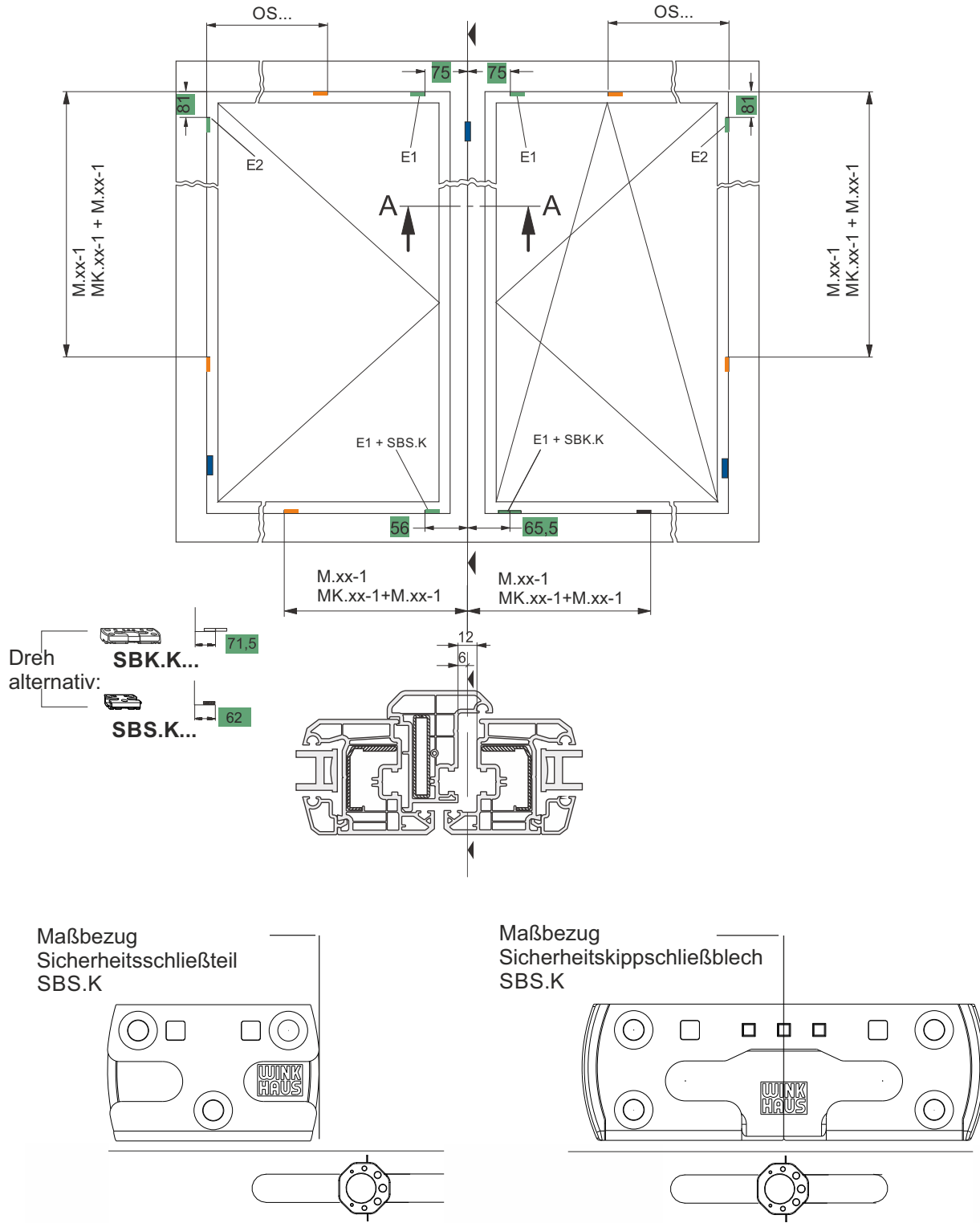

# Rahmenteilpositionen

## Mittenverriegelungen seitlich / unten

### Oberschiene

#### Bandseite

#### Verriegelungsabstand 800 mm

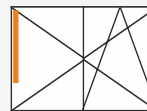

#### konstanter + mittiger Griffsitz

FFH min/max	M../MK..		SB Positionen.	
861 - 1285	M.500-1		500	
1286 - 1535	M.750-1	1	750	
1536 - 1785	MK.500-1 + M.500-1	1	500	1000
1786 - 2035	MK.750-1 + M.500-1	1	750	1250
2036 - 2285	MK.750-1 + MK.750-1	2	750	1500

#### Bandseite

#### Verriegelungsabstand 700 mm



#### konstanter + mittiger Griffsitz

FFH min/max	M../MK..		SB Positionen	
760 - 1185	M.500-1		500	
1186 - 1435	M.750-1	1	750	
1436 - 1685	MK.500-1 + M.500-1	1	500	1000
1686 - 1935	MK.750-1 + M.500-1	1	750	1250
1936 - 2185	MK.500-1 + MK.500-1 + M.500-1	1	500	1000 1500
2185 - 2300	MK.750-1 + MK.500-1 + M.500-1	2	750	1000 1500

#### unten

#### Verriegelungsabstand 700 + 800 mm

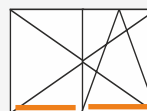



#### konstanter + mittiger Griffsitz

FFB min/max	M../MK..		SB Positionen.	
270 - 630	M.250-1	1	230	
631 - 1025	M.500-1	1	480	
1026 - 1250	M.750-1	1	730	
1251 - 1475	MK.500-1 + M.500-1	1	480	980
1476 - 1725	MK.750-1 + M.500-1	1	730	1230

#### Oberschiene

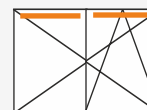
#### Verriegelungsabstand 700 + 800 mm



FFB min/max	M../MK..		SB Positionen.	
270 - 600	OS1.600	-	-	
601 - 800	OS2.800	-	-	
801 - 1025	OS2.1025-1	1	480	
1026 - 1250	OS2.1250-1	1	480	
1251 - 1725	OS2.1475-1 (+ZSR)	1	730	

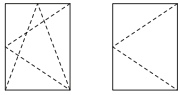

# activPilot Concept Drehfenster mit Bändern innen- und außen öffnend

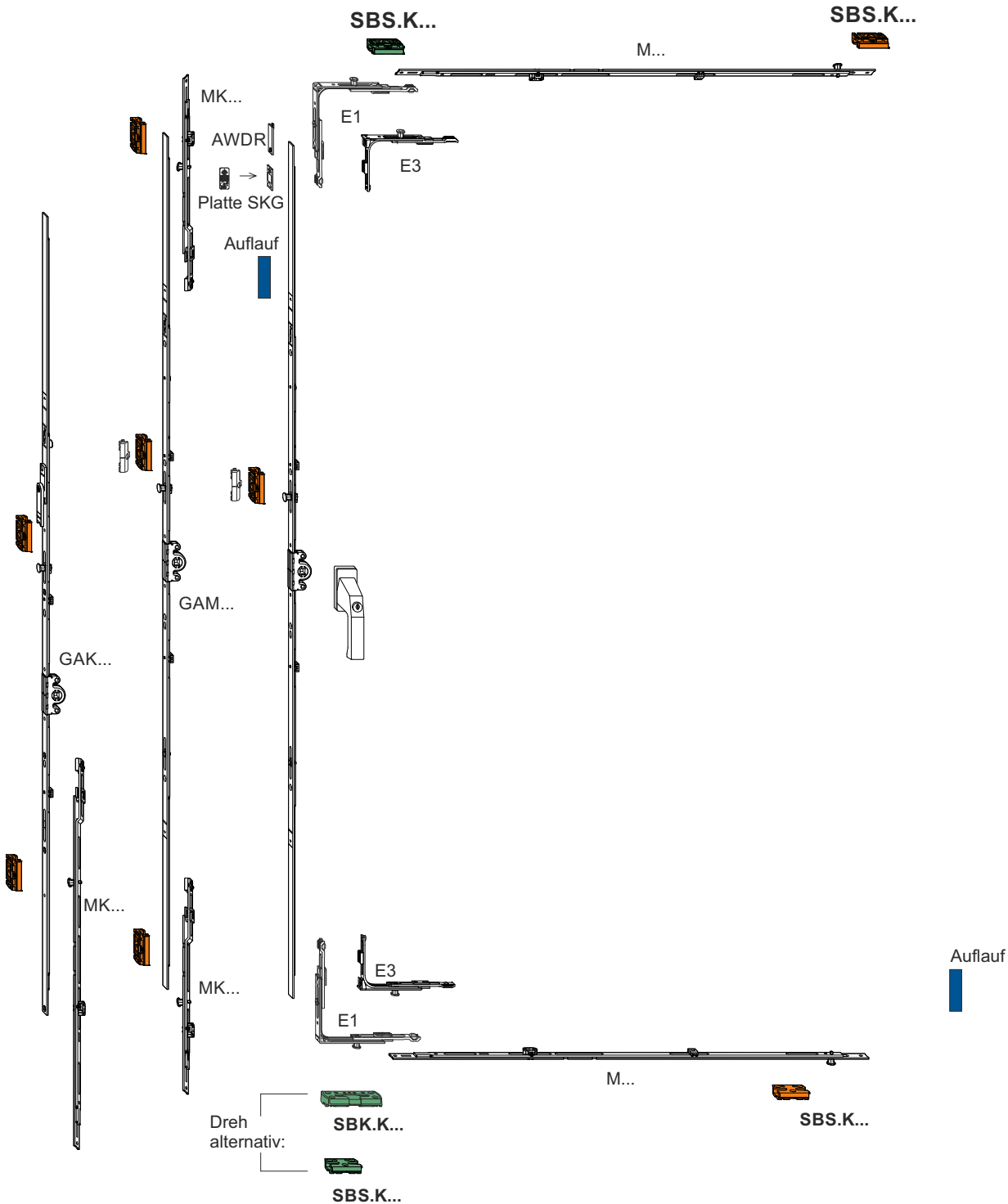

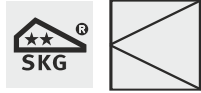

SKG geprüfte Bänder

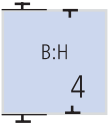
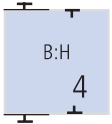

**activPilot Concept**  
**Drehfenster**  
**mit SKG geprüften Bändern**  
**innenöffnend, mittiger Griffsitz**

**211421**

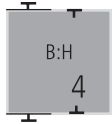
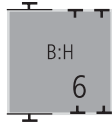
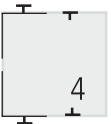
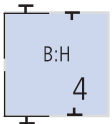
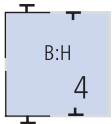
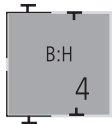
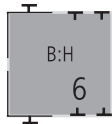
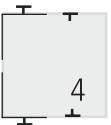
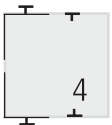
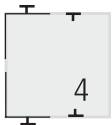
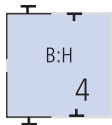
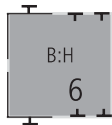
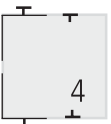
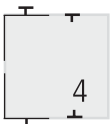
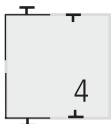
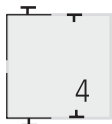
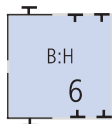
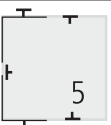
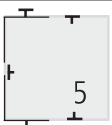
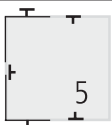
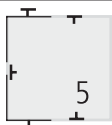
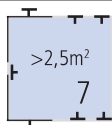
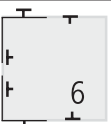
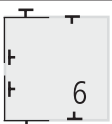
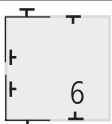
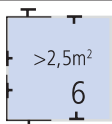
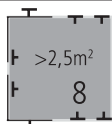
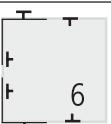
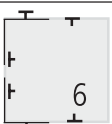
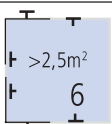
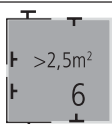
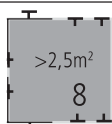
FFB / FFH	350 - 630	631 - 1025	1026 - 1250	1251 - 1475	1476 - 1725			V800*
	M.250-1	M.500-1	M.750-1	MK.500-1 M.500-1	MK.500-1 M.750-1			
<b>325 - 510</b> GAM.800	 B:H 4	 B:H 4	 B:H 4	 B:H 4	 B:H 6			<b>SKG geprüfte Bänder</b>
<b>511 - 710</b> GAM.800	 4	 B:H 4	 B:H 4	 B:H 4	 B:H 6			
<b>711 - 980</b> GAM.1050-1	 4	 4	 4	 B:H 4	 B:H 6			
<b>981 - 1300</b> GAM.1400-1	 4	 4	 4	 4	 B:H 6			
<b>1301 - 1400</b> GAM.1400-1	 5	 5	 5	 5	 >2,5m <sup>2</sup> 7			
<b>1401 - 1800</b> GAM.1800-2	 6	 6	 6	 >2,5m <sup>2</sup> 6	 >2,5m <sup>2</sup> 8			
<b>1801 - 2300</b> GAM.2300-3 (2x SBS)	 6	 6	 >2,5m <sup>2</sup> 6	 >2,5m <sup>2</sup> 6	 >2,5m <sup>2</sup> 8			
			* Verriegelungsabstand <b>700 mm</b> siehe Rahmenteilpositionen !					
	<b>350 - 630</b> M.250-1	<b>631 - 1025</b> M.500-1	<b>1026 - 1250</b> M.750-1	<b>1251 - 1475</b> MK.500-1 M.500-1	<b>1476 - 1725</b> MK.500-1 M.750-1			

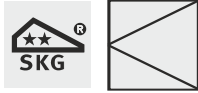

**activPilot Concept**  
**Drehfenster**  
**mit SKG geprüften Bändern**  
**innenöffnend, konstanter Griffsitz**





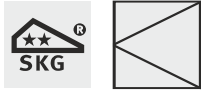





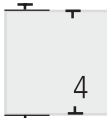
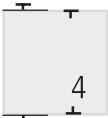
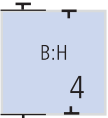
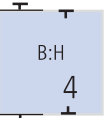
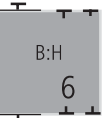

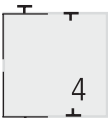
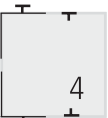
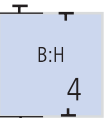

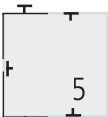
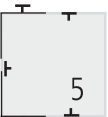

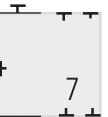

**211411**

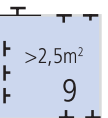
FFB / FFH	350 - 630 M.250-1	631 - 1025 M.500-1	1026 - 1250 M.750-1	1251 - 1475 MK.500-1 M.500-1	1476 - 1725 MK.500-1 M.750-1			V800* 	
<b>230 - 325</b> GAK.465	B:H 4	B:H 4	B:H 4	B:H 4	B:H 6				
<b>326 - 420</b> GAK.465	B:H 4	B:H 4	B:H 4	B:H 4	B:H 6				
<b>421 - 460</b> GAK.465	B:H 4	B:H 4	B:H 4	B:H 4	B:H 6				
<b>461 - 700</b> GAK.710	B:H 4	B:H 4	B:H 4	B:H 4	B:H 6			<b>SKG geprüfte Bänder</b>	
<b>701 - 850</b> GAK.945-1	B:H 4	B:H 4	B:H 4	B:H 4	B:H 6				
<b>851 - 1100</b> GAK.1100-1	B:H 4	B:H 4	B:H 4	B:H 4	B:H 6				
<b>1101 - 1325</b> GAK.1325-1	B:H 4	B:H 4	B:H 4	B:H 4	B:H 6				
<b>1326 - 1550</b> GAK.1550-1	B:H 5	B:H 5	B:H 5	B:H 5	B:H 7				
<b>1551 - 1775</b> GAK.1775-2	B:H 6	B:H 6	B:H 6	B:H 6	B:H 8 >2,5m <sup>2</sup>				
<b>1776 - 2000</b> GAK.2000-2	B:H 6	B:H 6	B:H 6	B:H 6 >2,5m <sup>2</sup>	B:H 8 >2,5m <sup>2</sup>				
<b>2001 - 2225</b> GAK.2225-2	B:H 6	B:H 6	B:H 6 >2,5m <sup>2</sup>	B:H 6 >2,5m <sup>2</sup>	B:H 8 >2,5m <sup>2</sup>	* Verriegelungsabstand <b>700 mm</b> siehe Rahmenteilpositionen !			
	<b>350 - 630</b> M.250-1	<b>631 - 1025</b> M.500-1	<b>1026 - 1250</b> M.750-1	<b>1251 - 1475</b> MK.500-1 M.500-1	<b>1475 - 1725</b> MK.500-1 M.750-1				

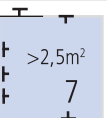
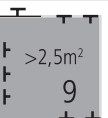

**activPilot Concept**  
**Drehfenster**  
**mit SKG geprüften Bändern**  
**außenöffnend, mittiger Griffsitz**

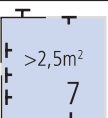
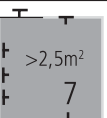
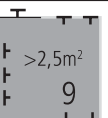



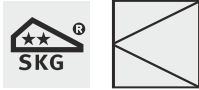





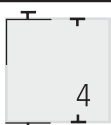

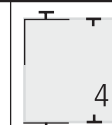
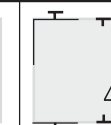
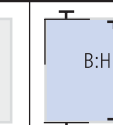
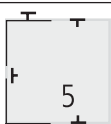
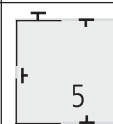
**211422**

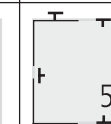
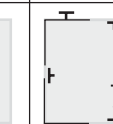
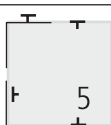
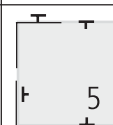
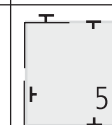
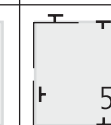
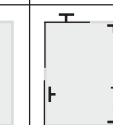
FFB / FFH	350 - 630	631 - 1025	1026 - 1250	1251 - 1475	1476 - 1725			V800* 
	M.250-1	M.500-1	M.750-1	MK.500-1 M.500-1	MK.500-1 M.750-1			
<b>700 - 900</b> GAM.1400-1	 4	 4	 B:H 4	 B:H 4	 B:H 6			<b>SKG geprüfte Bänder</b>
<b>901 - 1300</b> GAM.1400-1	 4	 4	 4	 B:H 4	 B:H 6			
<b>1301 - 1400</b> GAM.1400-1	 5	 5	 5	 5	 7			
<b>1401 - 1800</b> MK.250-1 GAM.1400-1 MK.250-1	 7	 7	 7	 7	 >2,5m <sup>2</sup> 9			
<b>1801 - 1900</b> MK.250-1 GAM.1400-1 MK.250-1	 7	 7	 7	 >2,5m <sup>2</sup> 7	 >2,5m <sup>2</sup> 9			
<b>1901 - 2300</b> MK.500-1 GAM.1400-1 MK.500-1	 7	 7	 >2,5m <sup>2</sup> 7	 >2,5m <sup>2</sup> 7	 >2,5m <sup>2</sup> 9			
	Dornmaß des Getriebes entsprechend Profil- situation auswählen ! (> D15,5)							
	* Verriegelungsabstand <b>700 mm</b> siehe Rahmenteilpositionen							
	<b>350 - 630</b> M.250-1	<b>631 - 1025</b> M.500-1	<b>1026 - 1250</b> M.750-1	<b>1251 - 1475</b> MK.500-1 M.500-1	<b>1475 - 1725</b> MK.500-1 M.750-1			

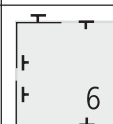
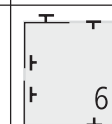
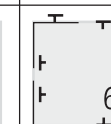
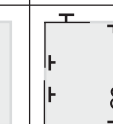

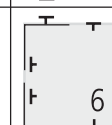
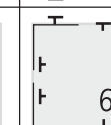
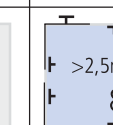
**activPilot Concept**  
**Drehfenster**  
**mit SKG geprüften Bändern**  
**außenöffnend, konstanter Griffsitz**

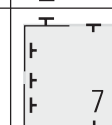
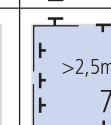
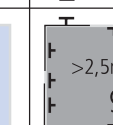
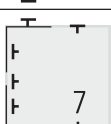
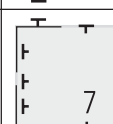
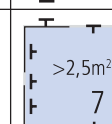
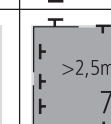
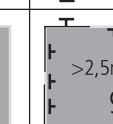
**211412**

FFB / FFH	350 - 630	631 - 1025	1026 - 1250	1251 - 1475	1476 - 1725			V800*
	M.250-1	M.500-1	M.750-1	MK.500-1 M.500-1	MK.500-1 M.750-1			
<b>975 - 1075</b> GAK.1325-1								<b>SKG geprüfte Bänder</b>
<b>1076 - 1325</b> GAK.1325-1								
<b>1326 - 1575</b> MK.250-1 GAK.1325-1								
<b>1576 - 1775</b> MK.500-1 GAK.1325-1								
<b>1776 - 1825</b> GAK.1325-1 MK.500-1								
<b>1826 - 2075</b> MK.250-1 GAK.1325-1 MK.500-1								
<b>2076 - 2225</b> MK.500-1 GAK.1325-1 MK.500-1								
	<div style="border: 2px solid black; padding: 5px;">                     Dornmaß des Getriebes                      entsprechend Profil-                      situation auswählen !                      (&gt; D15,5)                 </div>							
					* Verriegelungsabstand <b>700 mm</b> siehe Rahmenteilpositionen			
	<b>350 - 630</b> M.250-1	<b>631 - 1025</b> M.500-1	<b>1026 - 1250</b> M.750-1	<b>1251 - 1475</b> MK.500-1 M.500-1	<b>1475 - 1725</b> MK.500-1 M.750-1			





# Rahmenteilpositionen Maßbezüge Drehfenster

Mittiger Griffsitz  
GAM...

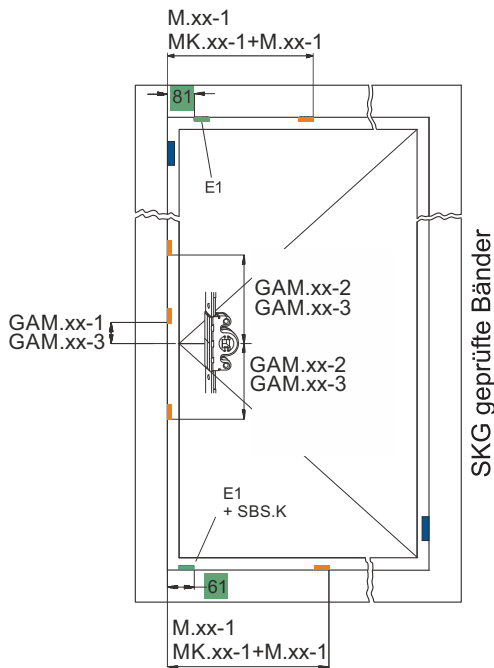

Konstanter Griffsitz  
GAK...

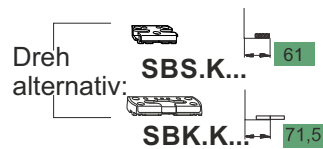
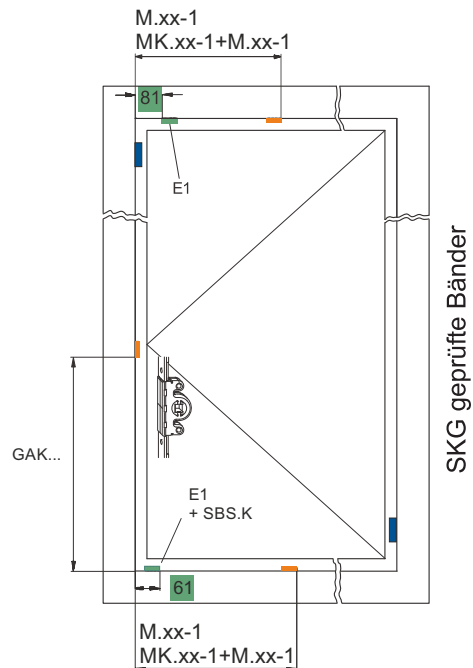

Maßbezug  
Sicherheitsschließteil  
SBS.K

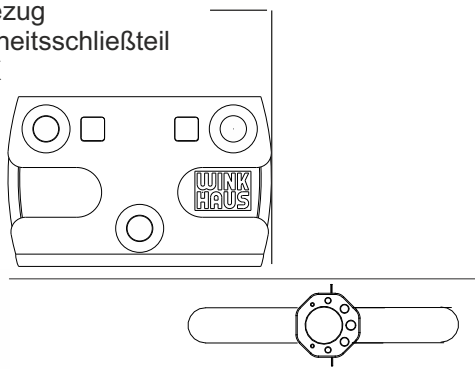

# Rahmenteilpositionen Getriebe

## Verriegelungsabstand 800 mm

### Konstanter Griffsitz 1 flg

FFH min/max	Getriebe		SB Positionen
230 - 460	GA..K.465		--
461 - 700	GA..K.710		--
701 - 850	GA..K.945-1		385
851 - 1100	GA..K.1100-1		500
1101 - 1325	GA..K.1325-1		750
1326 - 1550	GA..K.1550-1	1	<b>750</b>
1550 - 1775	GA..K.1775-2	2	<b>750 1250</b>
1776 - 2000	GA..K.2000-2	2	<b>750 1250</b>
2001 - 2225	GA..K.2225-2	2	<b>750 1500</b>



### mittiger Griffsitz 1 flg

FFH min/max	Getriebe		SB Positionen
230 - 325	GA..K.465		--
326 - 800	GA..M 800		--
800 - 1050	GA..M.1050-1		127
1051 - 1300	GA..M.1400-1		127
1301 - 1400	GA..M.1400-1	1	<b>127</b>
1401 - 1800	GA..M.1800-2	2	<b>-340 260</b>
1801 - 2300	GA..M.2300-3	2	<b>-520 127 692</b>



## Verriegelungsabstand 700 mm

### konstanter Griffsitz

FFH min/max	Getriebe		SB Positionen
230 - 460	GA..K.465		--
461 - 700	GA..K.710		--
701 - 850	GA..K.945-1		385
851 - 1100	GA..K.1100-1		500
1101 - 1325	GA..K.1325-2		385 750
1326 - 1550	GA..K.1550-2	1	385 <b>1000</b>
1551 - 1775	GA..K.1775-3	2	385 <b>750 1250</b>
1776 - 2000	GA..K.2000-4	2	385 <b>750 1250</b> 1500
2001 - 2225	GA..K.2225-4	2	385 <b>750 1250 1750</b>



### mittiger Griffsitz

FFH min/max	Getriebe		SB Positionen
230 - 325	GA..K.465		--
326 - 800	GA..M 800		--
800 - 1050	GA..M.1050-1		127
1051 - 1300	GA..M.1400-2		-223 127
1301 - 1400	GA..M.1400-2	1	-223 <b>127</b>
1401 - 1800	GA..M.1800-2	2	<b>-340 260</b>
1801 - 2300	GA..M..2300-3	2	<b>-520 127 692</b>



# Rahmenteilpositionen Getriebe mit Verlängerungen

## Mittiger Griffsitz

FFH min/max Getriebe  SB Positionen

700 - 1300	GA..M.1400-1		127
1301 - 2300	GA..M.1400-1	1	127

+ Mittenverriegelung			oben	unten
1401 - 1900	2x MK.250-1	2	250	230
1901 - 2300	2x MK.500-1	2	500	470

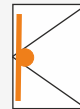

## konstanter Griffsitz

FFH min/max Getriebe  SB Positionen

975 - 1325	GA..K.1325-1		750
1326 - 2225	GA..K.1325-1	1	750

+Mittverriegelung			oben	unten
1326 - 1575	MK.250-1	1	250	
1576 - 1775	MK.500-1	1	500	
1776 - 1825	MK.500-1	1		470
1826 - 2075	MK.250-1	1	250	
	+MK.500-1	1		470
2075 - 2225	2x MK.250-1	2	500	470



# Rahmenteilpositionen Mittenverriegelungen

## Bandseite

### SKG geprüfte Bänder

Details zu geeigneten Produkten siehe  
[www.sterrenwijzer.nl](http://www.sterrenwijzer.nl)



## Unten

### Verriegelungsabstand 700mm



FFB min/max	M../MK..		SB Positionen
270 - 630	M.250-1	1	<b>230</b>
631 - 1025	M.500-1	1	<b>480</b>
1026 - 1250	M.750-1	1	<b>730</b>
1251 - 1475	MK.500-1+ M.500-1	1	500 <b>980</b>
1475 - 1725	MK.500-1+ M.750-1	1	500 <b>1230</b>

## Oben

### Verriegelungsabstand 700mm



FFB min/max	M../MK..		SB Positionen
270 - 630	M.250-1	1	<b>250</b>
631 - 1025	M.500-1	1	<b>500</b>
1026 - 1250	M.750-1	1	<b>750</b>
1251 - 1475	MK.500-1+ M.500-1	1	500 <b>1000</b>
1475 - 1725	MK.500-1+ M.750-1	1	500 <b>1250</b>



# activPilot Concept

## Kippfenster

## Klappfenster

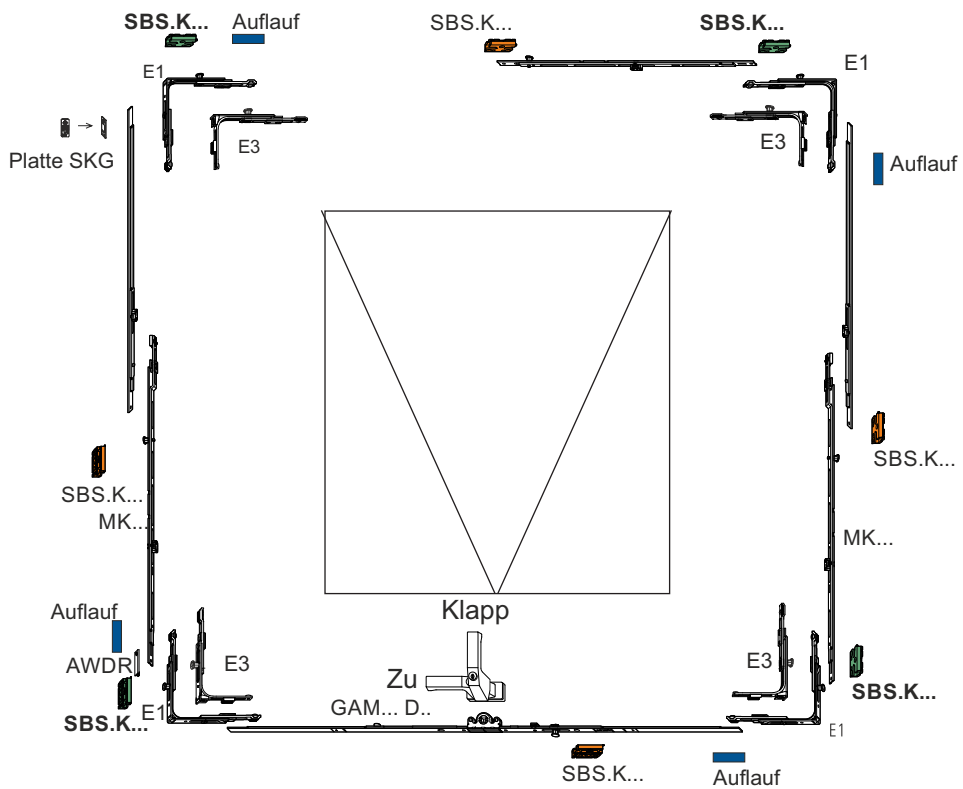
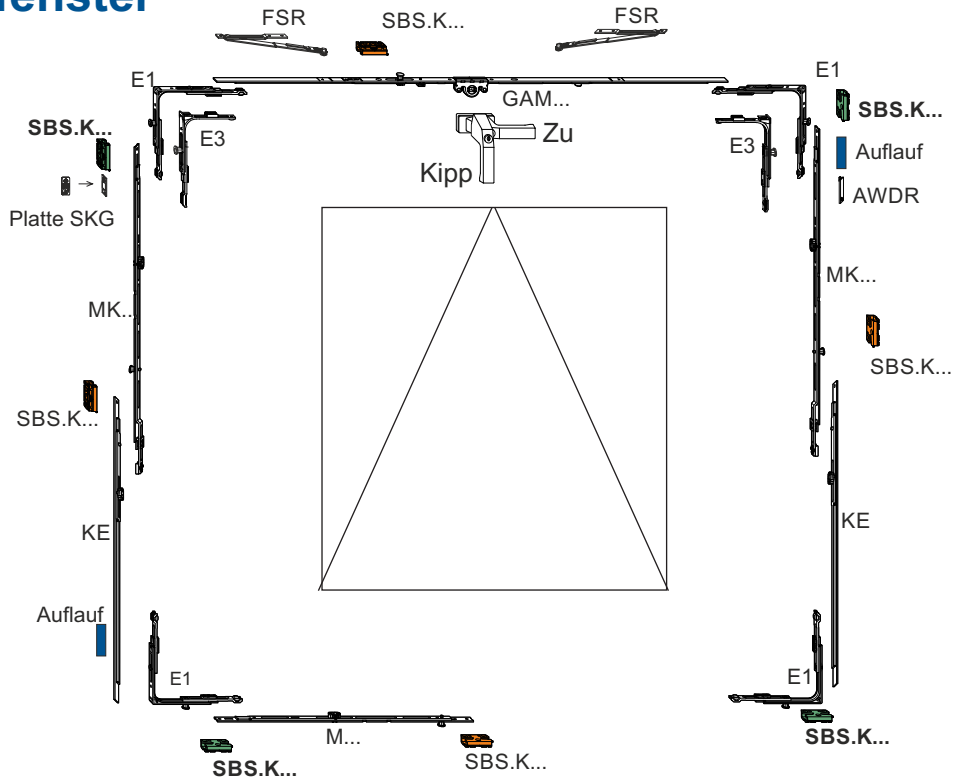





**activPilot Concept**  
**Klappfenster**  
**außenöffnend, mittiger Griffsitz**

**211822**

FFB / FFH	710 - 861	861 - 1285 M.500-1	1286 - 1535 M.750-1	1536 - 1785 MK.500-1 M.500-1	1786 - 2035 MK.750-1 M.500-1	2036 - 2300 MK.750-1 M.750-1	V800* 
360 - 460 KE							360 - 460 KE
461 - 710 KE							461 - 710 KE
711 - 960 KE MK.250-1							711 - 960 KE MK.250-1
961 - 1210 KE MK.500-1							961 - 1210 KE MK.500-1
1211 - 1450 KE M.750-1							1211 - 1450 KE M.750-1
*Verriegelungsabstand <b>700 mm</b> siehe Rahmenteilpositionen !							
		Dornmaß des Getriebes entsprechend Profil- situation auswählen ! (> D15,5)					
710 - 900 GAM.1400-1	901 - 1300 GAM.1400-1	1301 - 1400 GAM.1400-1	1401 - 1800 MK.250-1 GAM.1400-1 MK.250-1	1801 - 1900 MK.250-1 GAM.1400-1 MK.250-1	1901 - 2300 MK.500-1 GAM.1400-1 MK.500-1		





# Rahmenteilpositionen Maßbezüge Kipp-/ Klappfenster

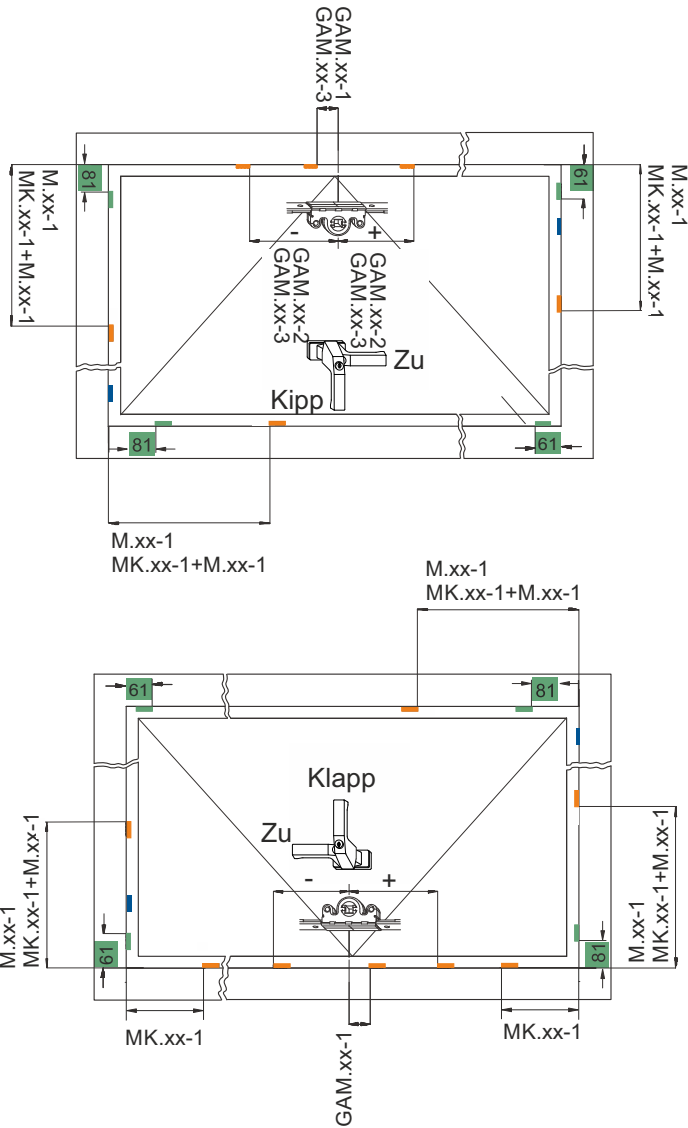

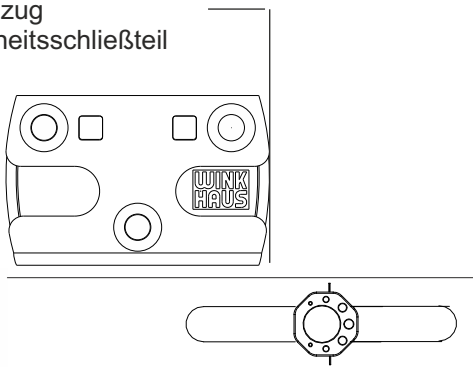

Maßbezug  
Sicherheitsschließsteil  
SBS.K



## Rahmenteilpositionen Getriebe



### Verriegelungsabstand 800 mm

#### mittiger Griffsitz 1 flg

FFB min/max	Getriebe		SB Positionen		
325 - 800	GA..M 800		--		
800 - 1050	GA..M.1050-1		-127		
1051 - 1300	GA..M.1400-1		-127		
1301 - 1400	GA..M.1400-1	1	-127		
1401 - 1800	GA..M.1800-2	2	340	-260	
1801 - 2300	GA..M.2300-3	2	520	-127	-692

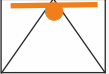

### Verriegelungsabstand 700 mm

#### mittiger Griffsitz

FFB min/max	Getriebe		SB Positionen		
325 - 800	GA..M 800		--		
800 - 1050	GA..M.1050-1		-127		
1051 - 1300	GA..M.1400-2		223	-127	
1301 - 1400	GA..M.1400-2	1	223	-127	
1401 - 1800	GA..M.1800-2	2	340	-260	
1801 - 2300	GA..M..2300-3	2	520	-127	-692

## Rahmenteilpositionen Getriebe mit Verlängerungen

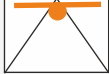
#### Mittiger Griffsitz

FFB min/max	Getriebe		SB Positionen		
710 - 1300	GA..M.1400-1		-127		
1301 - 2300	GA..M.1400-1	1	-127		
+ Mittsverriegelung			links	rechts	
1401 - 1900	2x MK.250-1	2	250	230	
1901 - 2300	2x MK.500-1	2	500	470	

# Rahmenteilpositionen Mittenverriegelungen

## seitlich Verriegelungsabstand 700mm

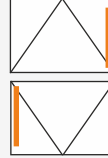

FFH min/max	M../MK..		SB Positionen
360 - 460	KE	-	-
461 - 710	MK.500-1+KE	1	480
711 - 960	MK.750-1+KE	1	730

## Seitlich Verriegelungsabstand 700mm

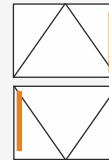

FFH min/max	M../MK..		SB Positionen
360 - 460	KE	-	-
461 - 710	MK.500-1+KE	1	500
711 - 960	MK.750-1+KE	1	750

## Mittenverriegelungen Oben / Unten



### Verriegelungsabstand 800 mm

#### konstanter + mittiger Griffsitz

FFH min/max	M../MK..		SB Positionen.
861 - 1285	M.500-1		500
1286 - 1535	M.750-1	1	750
1536 - 1785	MK.500-1 + M.500-1	1	500 1000
1786 - 2035	MK.750-1 + M.500-1	1	750 1250
2036 - 2285	MK.750-1 + MK.750-1	2	750 1500

### Verriegelungsabstand 700 mm

#### konstanter + mittiger Griffsitz

FFH min/max	M../MK..		SB Positionen
760 - 1185	M.500-1		500
1186 - 1435	M.750-1	1	750
1436 - 1685	MK.500-1 + M.500-1	1	500 1000
1686 - 1935	MK.750-1 + M.500-1	1	750 1250
1936 - 2185	MK.500-1 + MK.500-1+ M.500-1	1	500 1000 1500
2185 - 2300	MK.750-1 + MK.500-1+ M.500-1	2	750 1000 1500



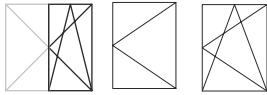



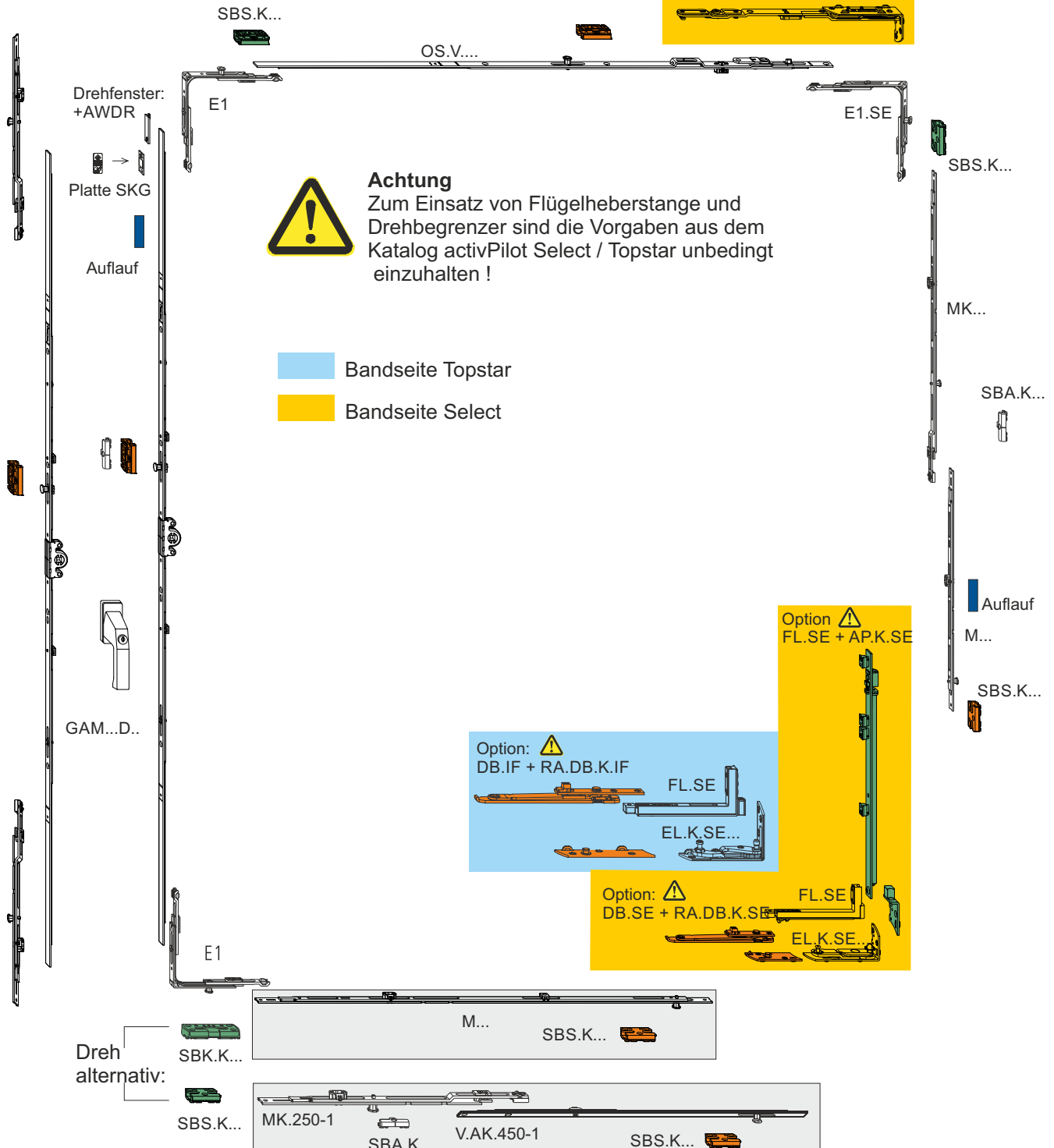
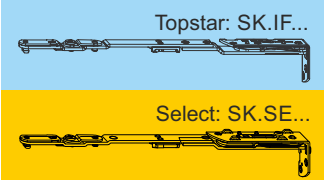







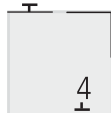
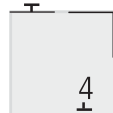
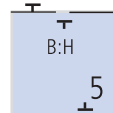
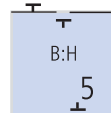
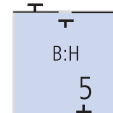

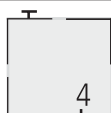
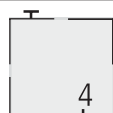
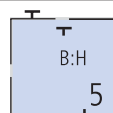
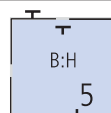
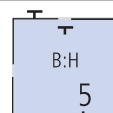
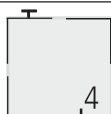
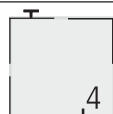
# activPilot Select / Topstar Dreh- Drehkipppfenster innen / außenöffnend

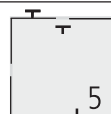
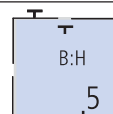
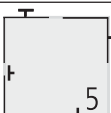
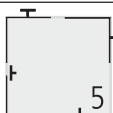
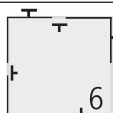
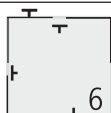
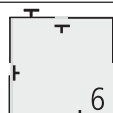
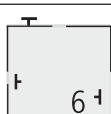
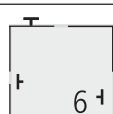
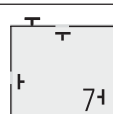
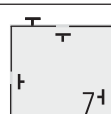
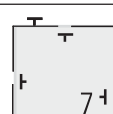
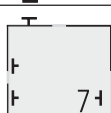
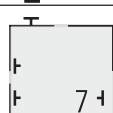
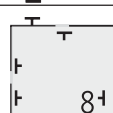
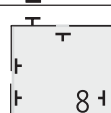

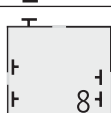

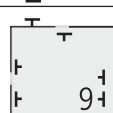
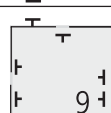
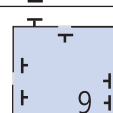
**activPilot Select / Topstar  
Drehkippenfenster  
innenöffnend, mittiger Griffsitz**

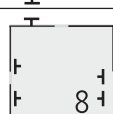
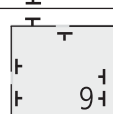
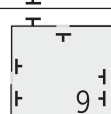
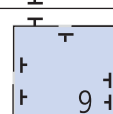

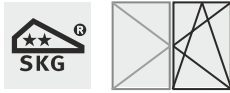

**231121**

FFB / FFH	485 - 550 OS.SE.550	551 - 800 OS.SE.800	801 - 1025 OS.SE.1025-1	1026 - 1250 OS.SE.1250-1	1251 - 1475 OS.SE.1250-1 +MK.250-1		V800* 
<b>325 - 510</b> GAM.800						<p>Hinweis nur für Select</p> 	
<b>510 - 710</b> GAM.800							
<b>711 - 980</b> GAM.1050-1							<b>860 - 980</b> M.500-1
<b>981 - 1300</b> GAM.1400-1							<b>981 -1285</b> M.500-1
<b>1301 - 1400</b> GAM.1400-1							<b>1286- 1535</b> M.750-1
<b>1401 - 1800</b> GAM.1800-2							<b>1536 - 1785</b> MK.500-1 M.500-1
<b>1801 - 2000</b> GAM.2300-3 (2x SBS)							<b>1786 - 2035</b> MK.750-1 M.500-1
<b>2001 - 2300</b> GAM.2300-3 (2x SBS)						<b>2036 - 2300</b> MK.750-1 M.750-1	
						<p>* Verriegelungsabstand <b>700 mm</b> siehe Rahmenteilpositionen !</p>	
ohne Drehbegrenzer	<b>485* - 700</b> M.250-1	<b>701 - 1025</b> M.500-1	—	<b>1026 - 1250</b> M.750-1			
mit Drehbegrenzer	<b>570 - 815</b> M.250-1	<b>816 - 1065</b> M.500-1	—	<b>1066 - 1315</b> M.750-1	<p>DB.SE DB.IF</p> 		
	<b>600 - 850</b> V.AK.450-1	<b>851 - 1100</b> MK.250-1 V.AK.450-1	—	<b>1101 - 1350</b> MK.500-1 V.AK.450-1		<b>1351 - 1475</b> MK.750-1 V.AK.450-1	

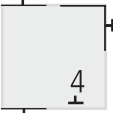
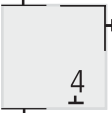
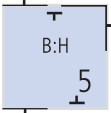
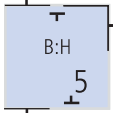
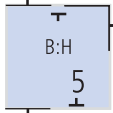

**activPilot Select / Topstar**  
**Stulpfenster, erstöffnender Flügel**  
**Drehkipp**  
**innenöffnend, mittiger Griffsitz**

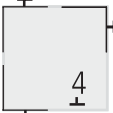
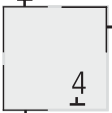
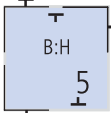
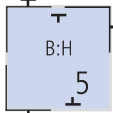
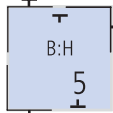
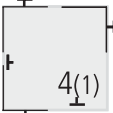
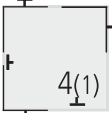
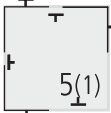
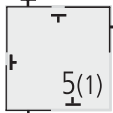
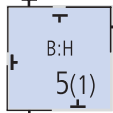
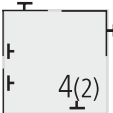
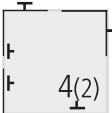
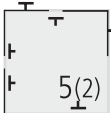
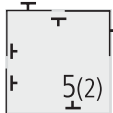
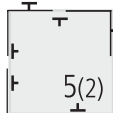
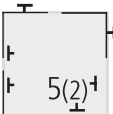
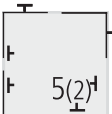
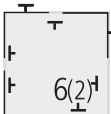
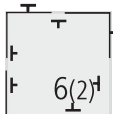
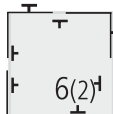
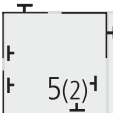
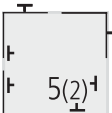
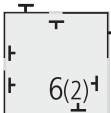
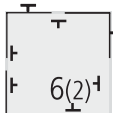
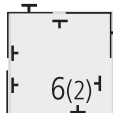
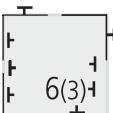
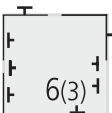
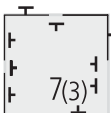
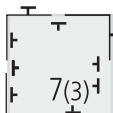
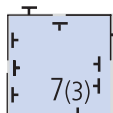
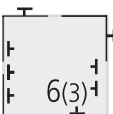
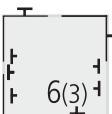
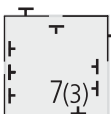
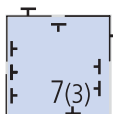
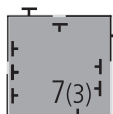
**231221**

FFB / FFH	485* - 550 OS.SE.550 Startmaß unten beachten !	551 - 800 OS.SE.800	801 - 1025 OS.SE.1025-1	1026 - 1250 OS.SE.1250-1	1251 - 1475 OS.SE.1250-1 +MK.250-1		V800* 
<b>410 - 560</b> GAM.800						<p>Hinweis nur für Select</p> 	
<b>560 - 710</b> GAM.800							
<b>711 - 980</b> GAM.1050-1							<b>860 - 980</b> M.500-1
<b>981 - 1300</b> GAM.1400-2							<b>981 - 1285</b> M.500-1
<b>1301 - 1400</b> GAM.1400-2							<b>1286 - 1535</b> M.750-1
<b>1401 - 1800</b> GAM.1800-2							<b>1536 - 1785</b> MK.500-1 M.500-1
<b>1801 - 2000</b> GAM.2300-3							<b>1786 - 2035</b> MK.750-1 M.500-1
<b>2001 - 2300</b> GAM.2300-3						<b>2036 - 2300</b> MK.750-1 M.750-1	
						<p>* Verriegelungsabstand <b>700 mm</b> siehe Rahmenteilpositionen</p>	
ohne Drehbegrenzer	<b>485* - 700</b> M.250-1	<b>701 - 1025</b> M.500-1	—	<b>1026 - 1250</b> M.750-1			
mit Drehbegrenzer	<b>570 - 815</b> M.250-1	<b>816 - 1065</b> M.500-1	—	<b>1066 - 1315</b> M.750-1		DB.SE DB.IF	
	<b>600 - 850</b> V.AK.450-1	<b>851 - 1100</b> MK.250-1 V.AK.450-1	—	<b>1101 - 1350</b> MK.500-1 V.AK.450-1			<b>1351 - 1475</b> MK.750-1 V.AK.450-1



**activPilot Select / Topstar**  
**Stulpfenster, zweitöffnender Flügel**  
**Dreh**  
**innenöffnend, mittiger Griffsitz**

**231221**









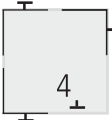
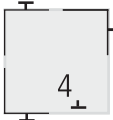
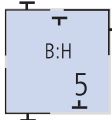
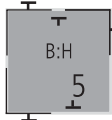
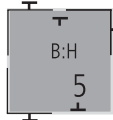

FFB / FFH	485* - 550 OS.SE.550 Startmaß unten beachten !	551 - 800 OS.SE.800	801 - 1025 OS.SE.1025-1	1026 - 1250 OS.SE.1250-1	1251 - 1475 OS.SE.1250-1 +MK.250-1		V800* 
<b>410 - 560</b> GASM.800						<p>Hinweis nur für Select</p> <p>Hinweis nur für Select FFH &gt; 1500</p>	* Verriegelungsabstand <b>700 mm</b> siehe Rahmenteilpositionen
<b>561 - 710</b> GASM.800							
<b>711 - 980</b> GASM.1050-1							<b>860 - 980</b> M.500-1
<b>981 - 1300</b> GASM.1400-2							<b>981 - 1285</b> M.500-1
<b>1301 - 1400</b> GASM.1400-2							<b>1286 - 1535</b> M.750-1
<b>1401 - 1800</b> GASM.1800-2							<b>1536 - 1785</b> MK.500-1 M.500-1
<b>1801 - 2000</b> GASM.2300-3							<b>1786 - 2035</b> MK.750-1 M.500-1
<b>2001 - 2300</b> GASM.2300-3						<b>2036 - 2300</b> MK.750-1 M.750-1	
						* Verriegelungsabstand <b>700 mm</b> siehe Rahmenteilpositionen	
ohne Drehbegrenzer	<b>485 - 700</b> M.250-1	<b>701 - 1025</b> M.500-1	—	<b>1026 - 1250</b> M.750-1		 DB.SE DB.IF	
mit Drehbegrenzer	<b>570 - 815</b> M.250-1	<b>816 - 1065</b> M.500-1	—	<b>1066 - 1315</b> M.750-1	<b>1316 - 1475</b> MK.500-1 M.500-1	 DB.SE DB.IF	
	<b>600 - 850</b> V.AK.450-1	<b>851 - 1100</b> MK.250-1 V.AK.450-1	—	<b>1101 - 1350</b> MK.500-1 V.AK.450-1	<b>1351 - 1475</b> MK.750-1 V.AK.450-1		

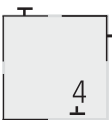
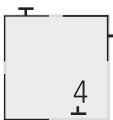
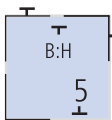
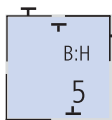
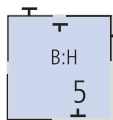
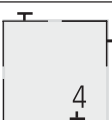
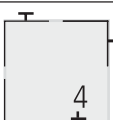
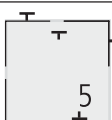
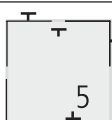
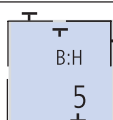
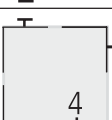
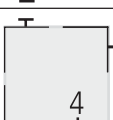
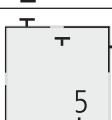
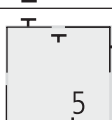
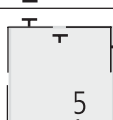
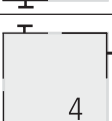
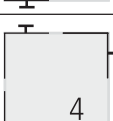
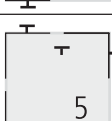
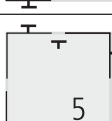
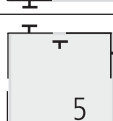
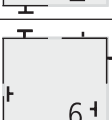
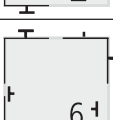
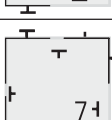
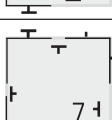
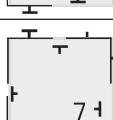
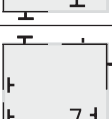
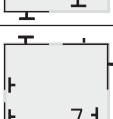
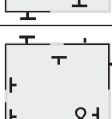
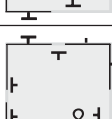
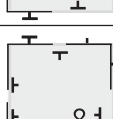

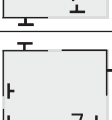
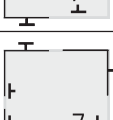
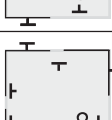
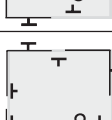

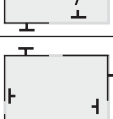
**activPilot Select / Topstat**  
**Drehkippenfenster**  
**innenöffnend, konstanter Griffsitz**

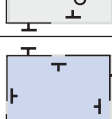
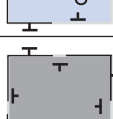
**231111**

FFB / FFH	485 - 550 OS.SE.550 Startmaß unten beachten !	551 - 800 OS.SE.800	801 - 1025 OS.SE.1025-1	1026 - 1250 OS.SE.1250-1	1251 - 1475 OS.SE.1250-1 +MK.250-1		V800* 
<b>420 - 460</b> GAK.465						Hinweis nur für Select 	*Verriegelungsabstand <b>700 mm</b> siehe Rahmenteilpositionen
<b>461 - 700</b> GAK.710							
<b>701 - 850</b> GAK.945-1							
<b>851 - 1100</b> GAK.1100-1							
<b>1101 - 1325</b> GAK.1325-1							
<b>1326 - 1550</b> GAK.1550-1							<b>860 - 980</b> M.500-1
<b>1551 - 1775</b> GAK.1775-2						Hinweis nur für Select FFH > 1500 	<b>981 - 1286</b> M.500-1
<b>1776 - 2000</b> GAK.2000-2							<b>1286 - 1535</b> M.750-1
<b>2001 - 2225</b> GAK.2225-2							<b>1536 - 1785</b> MK.500-1 M.500-1
ohne Drehbegrenzer	<b>485 - 700</b> M.250-1	<b>701 - 1025</b> M.500-1	—	<b>1026 - 1250</b> M.750-1			<b>1786 - 2035</b> MK.750-1 M.500-1
mit Drehbegrenzer	<b>570 - 815</b> M.250-1	<b>816 - 1065</b> M.500-1	—	<b>1066 - 1315</b> M.750-1	<b>1316 - 1475</b> MK.500-1 M.500-1		
	<b>600 - 850</b> V.AK.450-1	<b>851 - 1100</b> MK.250-1 V.AK.450-1	—	<b>1101 - 1350</b> MK.500-1 V.AK.450-1	<b>1351 - 1475</b> MK.750-1 V.AK.450-1		



**activPilot Select / Topstar**  
**Stulpfenster, erstöffnender Flügel**  
**Drehkipp**  
**innenöffnend, konstanter Griffsitz**

**231211**

FFB / FFH	485 - 550 OS.SE.550 Startmaß unten beachten!	551 - 800 OS.SE.800	801 - 1025 OS.SE.1025-1	1026 - 1250 OS.SE.1250-1	1251 - 1475 OS.SE.1250-1 +MK.250-1		V800* 
<b>450 - 460</b> GAK.465						Hinweis nur für Select 	* Verriegelungsabstand <b>700 mm</b> siehe Rahmenteilpositionen
<b>461 - 700</b> GAK.710							
<b>701 - 850</b> GAK.945-1							
<b>851 - 1100</b> GAK.1100-1							
<b>1101 - 1325</b> GAK.1325-2							
<b>1326 - 1550</b> GAK.1550-2							
<b>1551 - 1775</b> GAK.1775-2						Hinweis nur für Select FFH > 1500	<b>860 - 980</b> M.500-1
<b>1776 - 2000</b> GAK.2000-2						Hinweis nur für Select 	<b>1286 - 1535</b> M.750-1
<b>2001 - 2225</b> GAK.2225-2							<b>1536 - 1785</b> MK.500-1 M.500-1
<b>ohne Drehbegrenzer</b>	<b>485 - 700</b> M.250-1	<b>701 - 1025</b> M.500-1	—	<b>1026 - 1250</b> M.750-1	—		<b>1786 - 2035</b> MK.750-1 M.500-1
<b>mit Drehbegrenzer</b>	<b>570 - 815</b> M.250-1	<b>816 - 1065</b> M.500-1	—	<b>1066 - 1315</b> M.750-1	<b>1316 - 1475</b> MK.500-1 M.500-1	Hinweis nur für Select 	<b>2036 - 2225</b> MK.750-1 M.750-1
	<b>600 - 850</b> V.AK.450-1	<b>851 - 1100</b> MK.250-1 V.AK.450-1	—	<b>1101 - 1350</b> MK.500-1 V.AK.450-1	<b>1351 - 1475</b> MK.750-1 V.AK.450-1		

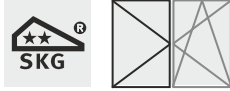

**activPilot Select / Topstar**  
**Stulpfenster, zweitöffnender Flügel**  
**Dreh**  
**innenöffnend, konstanter Griffsitz**

**231211**

FFB / FFH	485 - 550	551 - 800	801 - 1025	1026 - 1250	1251 - 1475		V800*
	OS.SE.550 Startmaß unten beachten !	OS.SE.800	OS.SE.1025-1	OS.SE.1250-1	OS.SE.1250-1 +MK.250-1		
<b>450 - 460</b> GASK.710						Hinweis nur für Select 	*Verriegelungsabstand <b>700 mm</b> siehe Rahmenteilpositionen
<b>461 - 700</b> GASK.710							
<b>701 - 850</b> GASK.945-1							
<b>851 - 1100</b> GASK.1100-1							
<b>1101 - 1325</b> GASK.1325-2							
<b>1326 - 1550</b> GASK.1550-2							<b>860 - 980</b> M.500-1
<b>1551 - 1775</b> GASK.1775-2						Hinweis nur für Select FFH > 1500 	<b>981 - 1286</b> M.500-1
<b>1776 - 2000</b> GASK.2000-2							<b>1286 - 1535</b> M.750-1
<b>2001 - 2225</b> GASK.2225-2							<b>1536 - 1785</b> MK.500-1 M.500-1
ohne Drehbegrenzer	<b>485 - 700</b> M.250-1	<b>701 - 1025</b> M.500-1	—	<b>1026 - 1250</b> M.750-1		DB.SE DB.IF 	
mit Drehbegrenzer	<b>570 - 815</b> M.250-1	<b>816 - 1065</b> M.500-1	—	<b>1066 - 1315</b> M.750-1	<b>1316 - 1475</b> MK.500-1 M.500-1		DB.SE DB.IF 
	<b>600 - 850</b> V.AK.450-1	<b>851 - 1100</b> MK.250-1 V.AK.450-1	—	<b>1101 - 1350</b> MK.500-1 V.AK.450-1	<b>1351 - 1475</b> MK.750-1 V.AK.450-1		

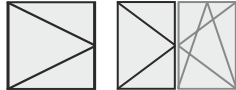

**activPilot Select / Topstar  
Dreh  
(1 flügelig und Stulp 1.öffnend)  
außenöffnend, mittiger Griffsitz**

**231722  
231922**

FFB / FFH	485 - 550 OS.SE.550	551 - 800 OS.SE.800	801 - 1025 OS.SE.1025-1	1026 - 1250 OS.SE.1250-1	1251 - 1475 OS.SE.1250-1 +MK.250-1		V800* 
<b>700 - 900</b> GAM.1400-1						<p>Hinweis nur für Select</p>  <p>FFH &gt; 1500</p>	<b>860 - 980</b> M.500-1
<b>901 - 1300</b> GAM.1400-1							<b>981 -1285</b> M.500-1
<b>1301- 1400</b> GAM.1400-1							<b>1286- 1535</b> M.750-1
<b>1401 - 1800</b> MK.250-1 GAM.1400-1 MK.250-1							<b>1536 - 1785</b> MK.500-1 M.500-1
<b>1801 - 1900</b> MK.250-1 GAM.1400-1 MK.250-1							<b>1786 - 2035</b> MK.750-1 M.500-1
<b>1901 - 2300</b> MK.250-1 GAM.1400-1 MK.250-1							<b>2036 - 2300</b> MK.750-1 M.750-1
	<p>Dornmaß des Getriebes entsprechend Profilsituation auswählen ! (&gt; D15,5)</p>						
						<p>* Verriegelungsabstand <b>700 mm</b> siehe Rahmenteilpositionen !</p>	
ohne Drehbegrenzer	<b>485 - 700</b> M.250-1	<b>701 - 1025</b> M.500-1	—	<b>1026 - 1250</b> M.750-1			
mit Drehbegrenzer	<b>565 - 810</b> M.250-1	<b>811 - 1060</b> M.500-1	—	<b>1061 - 1310</b> M.750-1	<p>DB.SE DB.IF</p>		
	<b>600 - 850</b> V.AK.450-1	<b>851 - 1100</b> MK.250-1 V.AK.450-1	—	<b>1101 - 1350</b> MK.500-1 V.AK.450-1		<b>1351 - 1475</b> MK.750-1 V.AK.450-1	

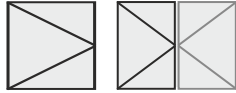

**activPilot Select / Topstar  
Dreh  
(1 flügelig und Stulp 1.öffnend)  
außenöffnend, konstanter Griffsitz**

**231712  
231912**

FFB	485 - 550	551 - 800	801 - 1025	1026 - 1250	1251 - 1475			V800*
FFH	OS.SE.550 Startmaß unten beachten !	OS.SE.800	OS.SE.1025-1	OS.SE.1250-1	OS.SE.1250-1 +MK.250-1			
975 - 1075 GAK.1325-1						<p>Hinweis nur für Select</p>		975 - 1075 M.500-1
1076 - 1325 GAK.1325-1							1076 - 1285 M.500-1	
1326 - 1575 MK.250-1 GAK.1325-1							1286 - 1535 M.750-1	
1576 - 1775 MK.500-1 GAK.1325-1							FFH > 1500	1536 - 1785 MK.500-1 M.500-1
1776 - 1825 GAK.1325-1 MK.500-1								1786 - 2035 MK.750-1 M.500-1
1826 - 2075 MK.250-1 GAK.1325-1 MK.500-1								↓
2076 - 2225 MK.500-1 GAK.1325-1 MK.500-1								2036 - 2225 MK.750-1 M.750-1
	Dornmaß des Getriebes entsprechend Profilsituation auswählen ! (> D15,5)							
								* Verriegelungsabstand 700 mm siehe Rahmenteilpositionen !
ohne Drehbegrenzer	485* - 700 M.250-1	701 - 1025 M.500-1	→	1026 - 1250 M.750-1				
mit Drehbegrenzer	570 - 815 M.250-1	816 - 1065 M.500-1	→	1066 - 1315 M.750-1	1316 - 1475 MK.500-1 M.500-1			
	600 - 850 V.AK.450-1	851 - 1100 MK.250-1 V.AK.450-1	→	1101 - 1350 MK.500-1 V.AK.450-1	1351 - 1475 MK.750-1 V.AK.450-1			

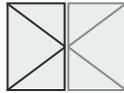

**activPilot Select / Topstar  
Dreh  
Stulpfenster,zweitöffnender Flügel  
außenöffnend, mittiger Griffsitz**

**231922**

FFB / FFH	485 - 600 OS.SE.550 Startmaß unten beachten !	601 - 800 OS.SE.800	801 - 1025 OS.SE.1025-1	1026 - 1250 OS.SE.1250-1	1251 - 1475 OS.SE.1250-1 +MK.250-1		V800* 	
<b>700 - 900</b> GASM.1400-1						<p>Hinweis nur für Select</p>	<b>860 - 980</b> M.500-1	
<b>901 - 1300</b> GASM.1400-1							<b>981 - 1285</b> M.500-1	
<b>1301 - 1400</b> GASM.1400-1							<b>1286 - 1535</b> M.750-1	
<b>1401 - 1800</b> MK.250-1 GASM.1400-1 MK.250-1							<p>FFH &gt; 1500</p>	<b>1536 - 1785</b> MK.500-1 M.500-1
<b>1801 - 2000</b> MK.SO.250-1 GASM.1400-1 MK.SU.250-1								<b>1786 - 2035</b> MK.750-1 M.500-1
<b>2001 - 2300</b> MK.SO.250-1 GASM.1400-1 MK.SU.250-1								<b>2036 - 2300</b> MK.750-1 M.750-1
						<p>* Verriegelungsabstand <b>700 mm</b> siehe Rahmenteilpositionen !</p>		
ohne Drehbegrenzer	<b>485* - 700</b> M.250-1	<b>701 - 1025</b> M.500-1	—	<b>1026 - 1250</b> M.750-1				
mit Drehbegrenzer	<b>570 - 815</b> M.250-1	<b>816 - 1065</b> M.500-1	—	<b>1066 - 1315</b> M.750-1	<b>1315 - 1475</b> MK.500-1 M.500-1	<p>DB.SE DB.IF</p>		
	<b>600* - 850</b> V.AK.450-1	<b>851 - 1100</b> MK.250-1 V.AK.450-1	—	<b>1101 - 1350</b> MK.500-1 V.AK.450-1	<b>1351 - 1475</b> MK.750-1 V.AK.450-1			



# activPilot Select / Topstar Dreh

## Stulpfenster, zweitöffnender Flügel außenöffnend, konstanter Griffsitz

# 231912

FFB / FFH	485 - 550 OS.SE.550	551 - 800 OS.SE.800	801 - 1025 OS.SE.1025-1	1026 - 1250 OS.SE.1250-1	1251 - 1475 OS.SE.1250-1 +MK.250-1		V800* 
<b>975 - 1075</b> GASK.1325-1							<b>975 - 1075</b> M.500-1
<b>1076 - 1325</b> GASK.1325-1*							<b>1076 - 1285</b> M.500-1
<b>1326 - 1575</b> MK.SO.250-1 GASK.1325-1*							<b>1286 - 1535</b> M.750-1
<b>1576 - 1775</b> MK.SO.500-1 GASK.1325-1*							<b>1536 - 1785</b> MK.500-1 M.500-1
<b>1776 - 1825</b> GASK.1325-1* MK.SU.500-1							<b>1786 - 2035</b> MK.750-1 M.500-1
<b>1826 - 2075</b> MK.SO.250-1 GASK.1325-1* MK.SU.500-1							↓
<b>2076 - 2225</b> MK.SO.500-1 GASK.1325-1* MK.SU.500-1							<b>2036 - 2225</b> MK.750-1 M.750-1
						* Verriegelungsabstand <b>700 mm</b> siehe Rahmenteilpositionen !	
ohne Drehbegrenzer	<b>485 - 700</b> M.250-1	<b>701 - 1025</b> M.500-1	—	<b>1026 - 1250</b> M.750-1			
mit Drehbegrenzer	<b>570 - 815</b> M.250-1	<b>816 - 1065</b> M.500-1	—	<b>1066 - 1315</b> M.750-1	<b>1316 - 1475</b> MK.500-1 M.500-1		
	<b>600 - 850</b> V.AK.450-1	<b>851 - 1100</b> MK.250-1 V.AK.450-1	—	<b>1101 - 1350</b> MK.500-1 V.AK.450-1	<b>1351 - 1475</b> MK.750-1 V.AK.450-1		





# Rahmenteilpositionen Maßbezüge DK Fenster

Mittiger Griffsitz  
GAM...

Konstanter Griffsitz  
GAK...

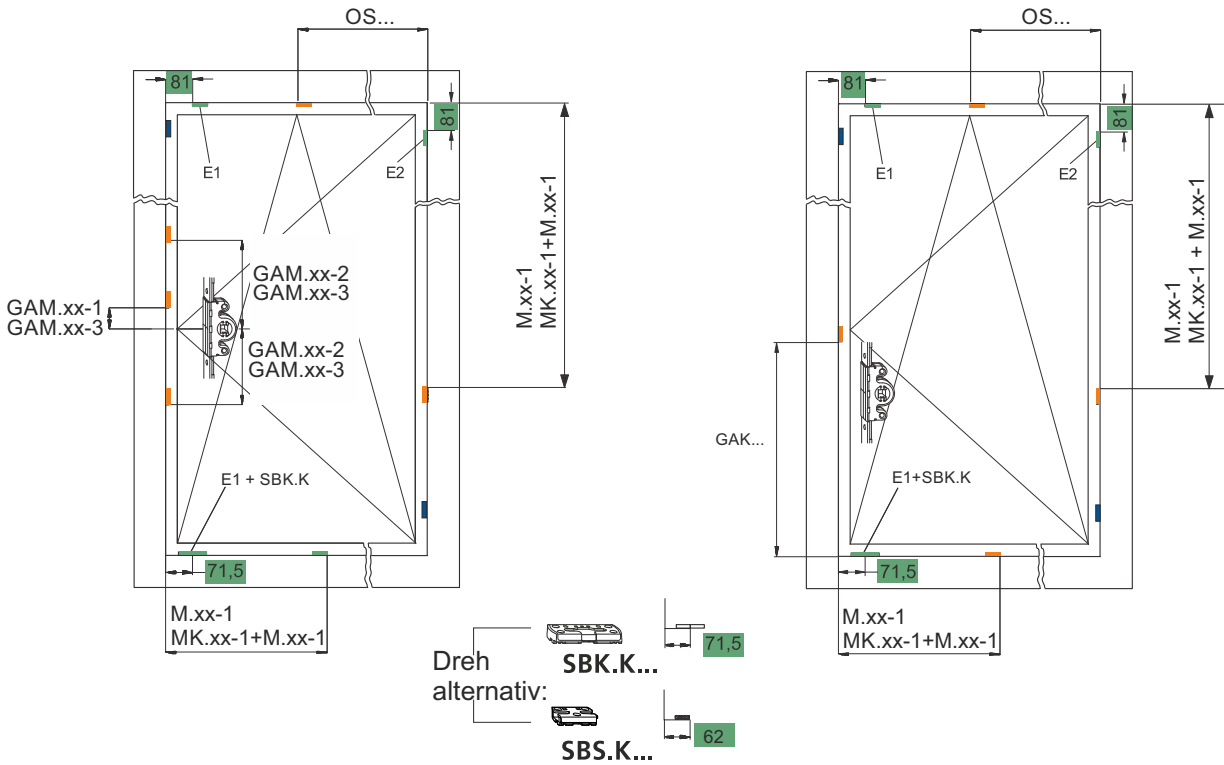

Maßbezug  
Sicherheitsschließteil  
SBS.K

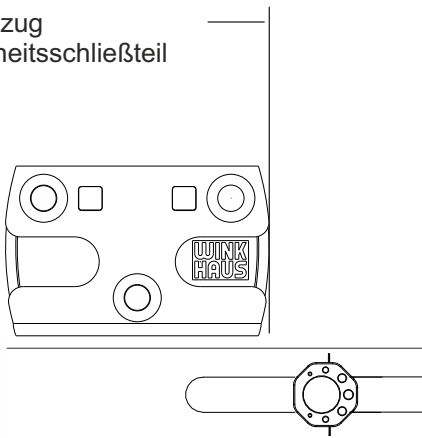

Maßbezug  
Sicherheitskippschließblech  
SBS.K

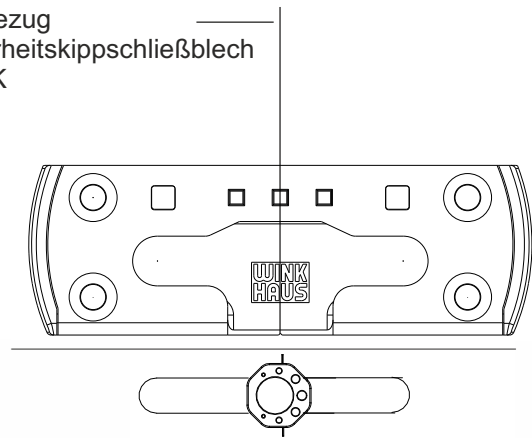

# Rahmenteilpositionen Getriebe

## Verriegelungsabstand 800 mm

### konstanter Griffsitz 1 flg

FFH min/max	Getriebe		SB Positionen
420 - 460	GA..K.465		--
461 - 700	GA..K.710		--
701 - 850	GA..K.945-1		385
851 - 1100	GA..K.1100-1		500
1101 - 1325	GA..K.1325-1		750
1326 - 1550	GA..K.1550-1	1	<b>750</b>
1550 - 1775	GA..K.1775-2	2	<b>750 1250</b>
1776 - 2000	GA..K.2000-2	2	<b>750 1250</b>
2001 - 2225	GA..K.2225-2	2	<b>750 1500</b>



### mittiger Griffsitz 1 flg

FFH min/max	Getriebe		SB Positionen
326 - 800	GA..M 800		--
800 - 1050	GA..M.1050-1		127
1051 - 1300	GA..M.1400-1		127
1301 - 1400	GA..M.1400-1	1	<b>127</b>
1401 - 1800	GA..M.1800-2	2	<b>-340 260</b>
1801 - 2300	GA..M.2300-3	2	<b>-520 127 692</b>

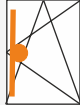

## Verriegelungsabstand 700 mm

### konstanter Griffsitz

FFH min/max	Getriebe		SB Positionen
420 - 460	GA..K.465		--
461 - 700	GA..K.710		--
701 - 850	GA..K.945-1		385
851 - 1100	GA..K.1100-1		500
1101 - 1325	GA..K.1325-2		385 750
1326 - 1550	GA..K.1550-2	1	385 <b>1000</b>
1551 - 1775	GA..K.1775-3	2	385 <b>750 1250</b>
1776 - 2000	GA..K.2000-4	2	385 <b>750 1250</b> 1500
2001 - 2225	GA..K.2225-4	2	385 <b>750 1250 1750</b>

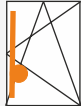

### mittiger Griffsitz

FFH min/max	Getriebe		SB Positionen
325 - 800	GA..M 800		--
800 - 1050	GA..M.1050-1		127
1051 - 1300	GA..M.1400-2		-223 127
1301 - 1400	GA..M.1400-2	1	-223 <b>127</b>
1401 - 1800	GA..M.1800-2	2	<b>-340 260</b>
1801 - 2300	GA..M..2300-3	2	<b>-520 127 692</b>

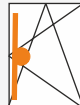



# Rahmenteilpositionen Mittenverriegelungen Oberschiene

## Bandseite

### Verriegelungsabstand 800 mm



#### konstanter + mittiger Griffsitz

FFH min/max	M../MK..		SB Positionen.	
860 - 1285	M.500-1		500	
1286 - 1535	M.750-1	1	750	
1536 - 1785	MK.500-1 + M.500-1	1	500	1000
1786 - 2035	MK.750-1 + M.500-1	1	750	1250
2036 - 2300	MK.750-1 + MK.750-1	2	750	1500

## Bandseite

### Verriegelungsabstand 700 mm



#### konstanter + mittiger Griffsitz

FFH min/max	M../MK..		SB Positionen	
760 - 1185	M.500-1		500	
1186 - 1435	M.750-1	1	750	
1436 - 1685	MK.500-1 + *M.500-1	1	500	*1000
1686 - 1935	MK.750-1 + *M.500-1	1	750	*1250
1936 - 2185	MK.500-1 + MK.500-1+ *M.500-1	1	500	1000 *1500
2185 - 2300	MK.750-1 + MK.500-1+ *M.500-1	2	750	1000 *1500

\* Bei Einsatz Flügellagerschiene kann der Einsatz eine ablängbaren Mittenverriegelung V.AK.450-1 erforderlich sein. Der Verschlusspunkt ist in oberhalb der Flügellagerschiene zu setzen.



## unten

### Verriegelungsabstand 700 + 800 mm

FFB min/max	M../MK..		SB Positionen.	
siehe Beschlagmatrix	M.250-1	1	230	
	M.500-1	1	480	
	M.750-1	1	730	
	MK.500-1 + M.500-1	1	480	980
	MK.750-1 + M.500-1	1	730	1230

## Oberschiene

### Verriegelungsabstand 700 + 800 mm

FFB min/max	OS.SE..		SB Positionen.	
270 - 550	OS.SE.550	-	-	
551 - 800	OS.SE.800	-	-	
801 - 1025	OS2.SE.1025-1	1	480	
1026 - 1250	OS2.SE.1250-1	1	480	
1251 - 1475	MK.250-1+OS2.SE.1250-1	1	250	480





# duoPort SK 100 S / SK 160 S

Grundgarnitur SK 100 S / SK 160 S  
 Details siehe Katalog duoPort SK !

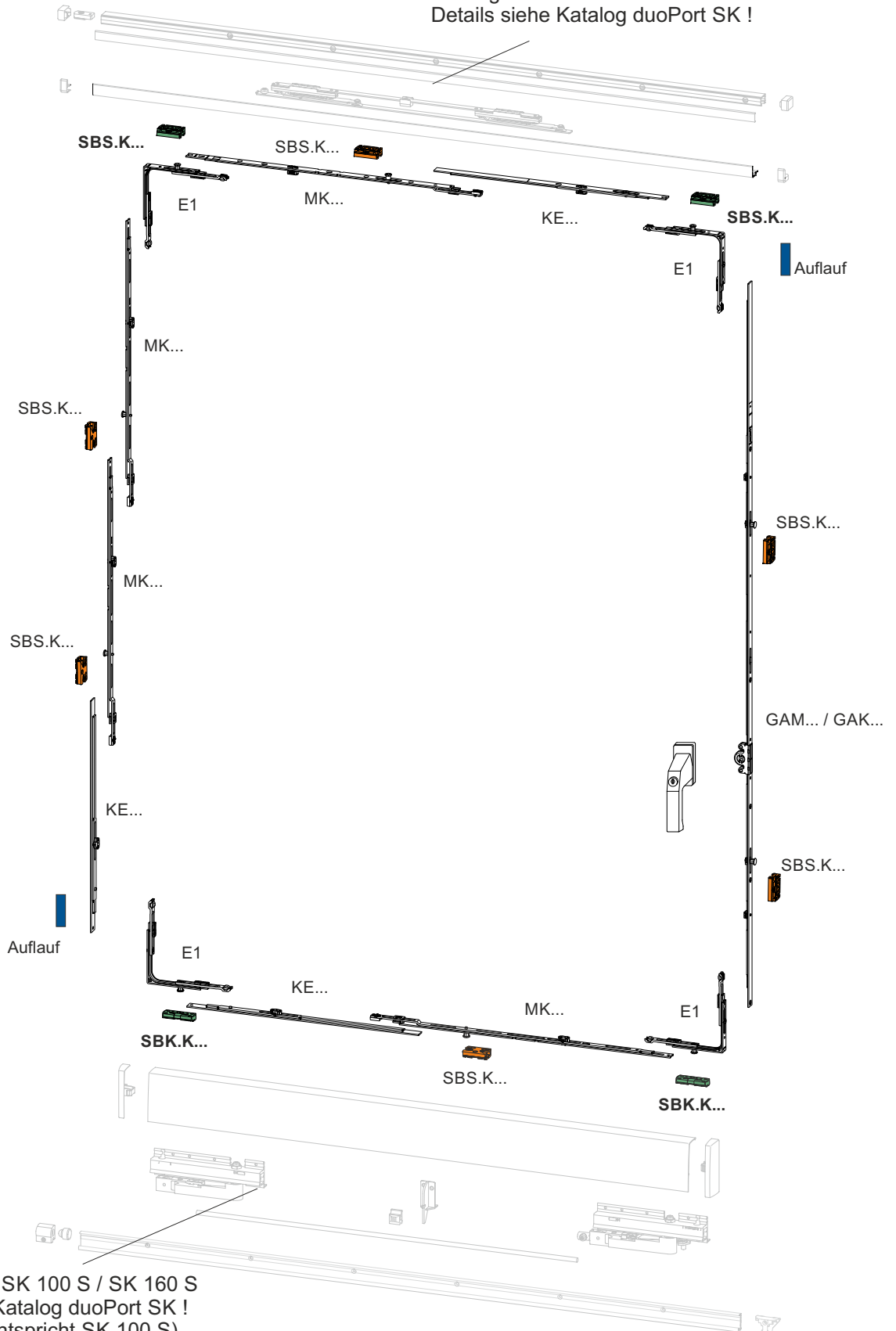

Grundgarnitur SK 100 S / SK 160 S  
 Details siehe Katalog duoPort SK !  
 (Darstellung entspricht SK 100 S)









# Rahmenteilpositionen Maßbezüge DuoPort SK 100 S / SK 160 S

Mittiger Griffsitz  
GAM...

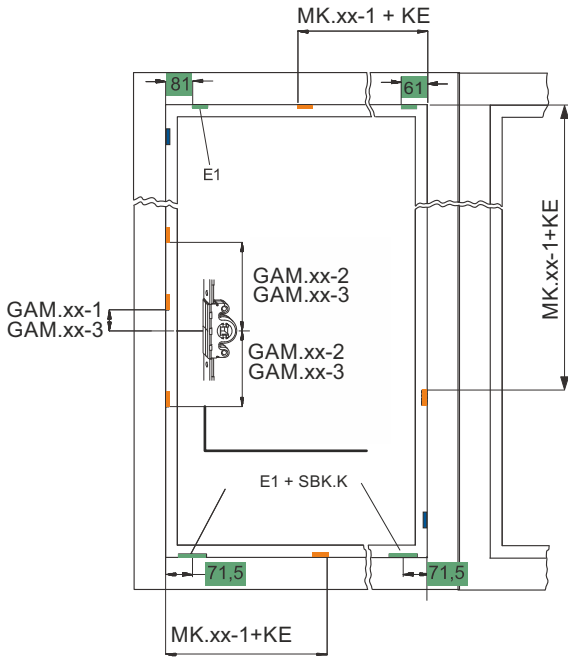

Konstanter Griffsitz  
GAK...

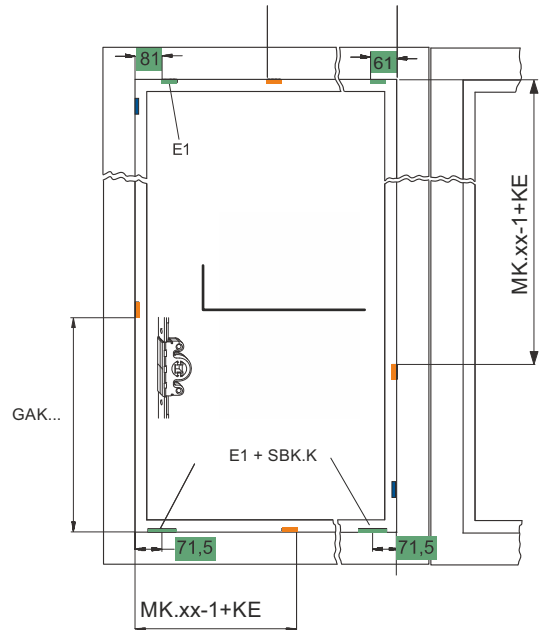

Maßbezug  
Sicherheitsschließteil  
SBS.K

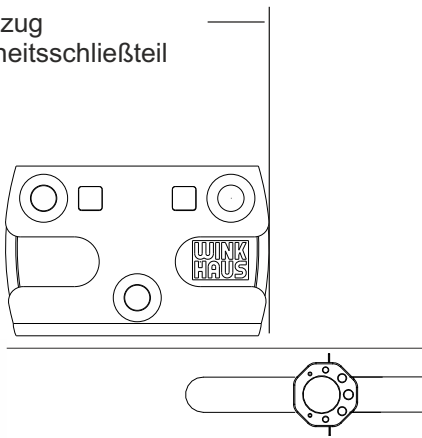

Maßbezug  
Sicherheitskippschließblech  
SBS.K

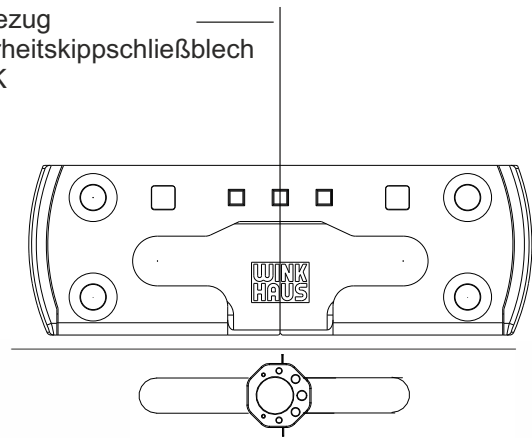

# Rahmenteilpositionen Getriebe

## Verriegelungsabstand 800 mm

### konstanter Griffsitz 1 flg

FFH min/max	Getriebe		SB Positionen
420 - 460	GA..K.465		--
461 - 700	GA..K.710		--
701 - 850	GA..K.945-1		385
851 - 1100	GA..K.1100-1		500
1101 - 1325	GA..K.1325-1		750
1326 - 1550	GA..K.1550-1	1	750
1550 - 1775	GA..K.1775-2	2	750 1250
1776 - 2000	GA..K.2000-2	2	750 1250
2001 - 2225	GA..K.2225-2	2	750 1500



### mittiger Griffsitz 1 flg

FFH min/max	Getriebe		SB Positionen
326 - 800	GA..M 800		--
800 - 1050	GA..M.1050-1		127
1051 - 1300	GA..M.1400-1		127
1301 - 1400	GA..M.1400-1	1	127
1401 - 1800	GA..M.1800-2	2	-340 260
1801 - 2300	GA..M.2300-3	2	-520 127 692



## Verriegelungsabstand 700 mm

### konstanter Griffsitz

FFH min/max	Getriebe		SB Positionen
420 - 460	GA..K.465		--
461 - 700	GA..K.710		--
701 - 850	GA..K.945-1		385
851 - 1100	GA..K.1100-1		500
1101 - 1325	GA..K.1325-2		385 750
1326 - 1550	GA..K.1550-2	1	385 1000
1551 - 1775	GA..K.1775-3	2	385 750 1250
1776 - 2000	GA..K.2000-4	2	385 750 1250 1500
2001 - 2225	GA..K.2225-4	2	385 750 1250 1750



### mittiger Griffsitz

FFH min/max	Getriebe		SB Positionen
325 - 800	GA..M 800		--
800 - 1050	GA..M.1050-1		127
1051 - 1300	GA..M.1400-2		-223 127
1301 - 1400	GA..M.1400-2	1	-223 127
1401 - 1800	GA..M.1800-2	2	-340 260
1801 - 2300	GA..M..2300-3	2	-520 127 692



# Rahmenteilpositionen Mittenverriegelungen

## oben / unten



FFB min/max	M../MK..		SB Positionen
710 - 960	MK.250-1 + KE	1	230
461 - 710	MK.500-1 + KE	1	480
711 - 960	MK.750-1 + KE	1	730

## Seitlich



FFH min/max	M../MK..		SB Positionen
650 - 710	KE	-	-
711 - 960	MK.250-1+KE	1	250
961 - 1210	MK.500-1+KE	1	500 (SBS ab FFH 1076)
1211 - 1460	MK.750-1+KE	1	750
1461 - 1710	2x MK.500-1+KE	1	500 1000
1711 - 1960	MK.500-1+MK.750-1+KE	2	500 1250
1961 - 2210	MK.750-1+MK.750-1+KE	2	750 1500
2211 - 2225	2xMK.500-1+MK.750-1+KE	2	500 1000 1750





# activPilot Comfort ERGO Drehkipppfenster mit Zwangssteuerung



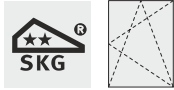

**activPilot Ergo**  
**Drehkippfenster mit Zwangssteuerung,**  
**innenöffnend,**  
**konstanter / mittiger Griffsitz**

# 441621

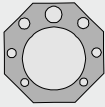
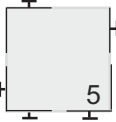
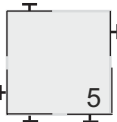
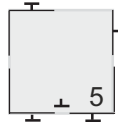
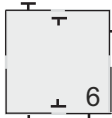
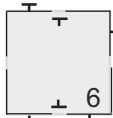
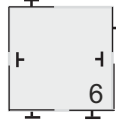
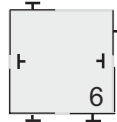
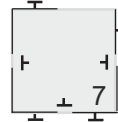
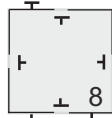
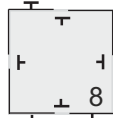
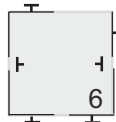
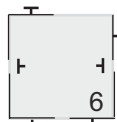
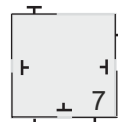
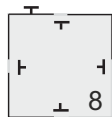
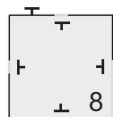
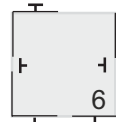
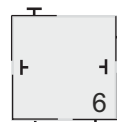
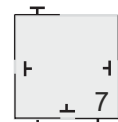
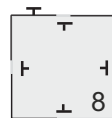
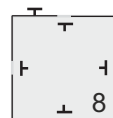
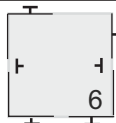
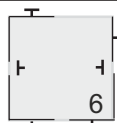
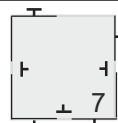
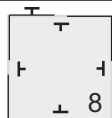
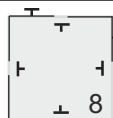
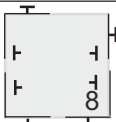
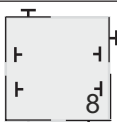
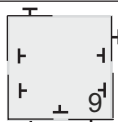
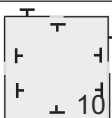
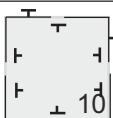
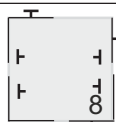
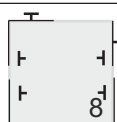
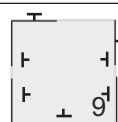
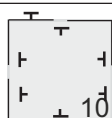
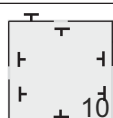
FFB / FFH	460 - 615	616 - 865		866 - 1115	1116 - 1200			
	OS.1.EG.615	OS.2.EG.865		OS.2.EG.865 MK.250-1	OS.2.EG.865 MK.500-1			
<b>460 - 710</b> KE								<b>460 - 710</b> KE
<b>711 - 960</b> MK.250-1 KE								<b>711 - 960</b> MK.250-1 KE
<b>961 - 1210</b> MK.500-1 KE								<b>961 - 1210</b> MK.500-1 KE
<b>1211 - 1460</b> MK.750-1 KE								<b>1211 - 1460</b> MK.750-1 KE
<b>1461 - 1710</b> 2x MK.500-1 KE								<b>1461 - 1710</b> 2x MK.500-1 KE
<b>1711 - 1960</b> MK.750-1 MK.500-1 KE								<b>1711 - 1960</b> MK.750-1 MK.500-1 KE
<b>1961 - 2210</b> MK.750-1 MK.750-1 KE								<b>1961 - 2210</b> MK.750-1 MK.750-1 KE
Griffsitz konstant	<b>460 - 580</b> GAK.710	<b>581 - 695</b> GAK.830	<b>696 - 945</b> GAK.945-1	<b>946 - 1100</b> GAK.1100-1	<b>1101 - 1200</b> GAK.1325-1			
Griffsitz mittig	<b>511 - 710</b> GAM.800		<b>711 - 1050</b> GAM.1050-1		<b>1051 - 1200</b> GAM.1400-1			

# Rahmenteilpositionen Maßbezüge activPilot Comfort

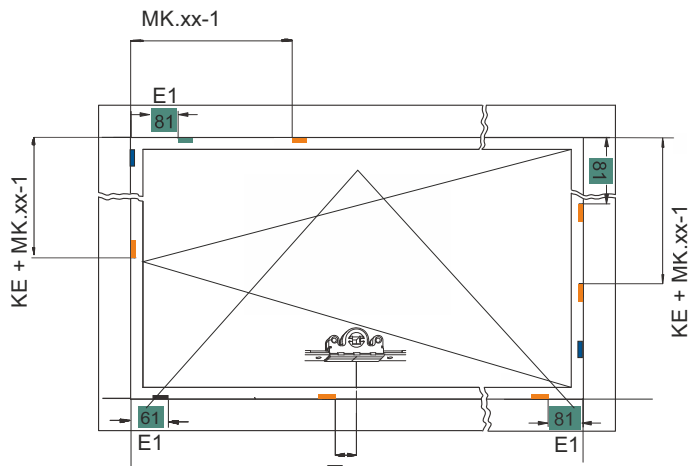
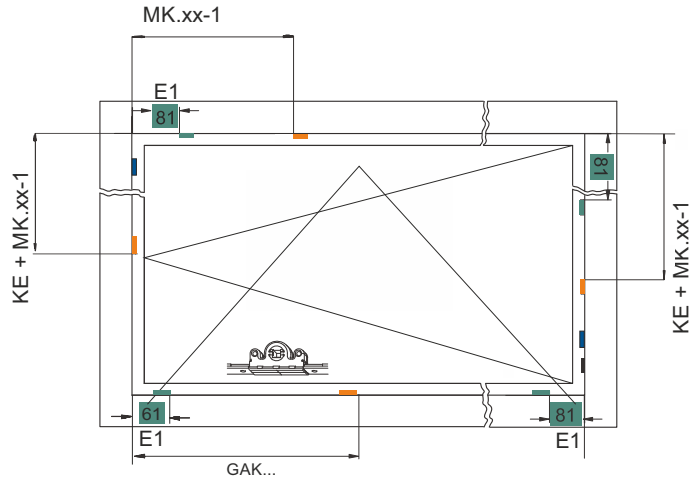

Maßbezug  
Sicherheitsschließteil  
SBS.K

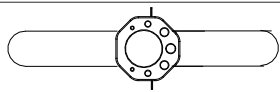
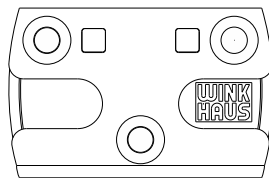

# Rahmenteilpositionen

## Getriebe Verriegelungsabstand 800 mm

### konstanter Griff Sitz

FFB min/max	Getriebe		SB Positionen
460 - 700	GA..K.710		--
701 - 850	GA..K.945-1	1	385
851 - 1100	GA..K.1100-1	1	500
1101 - 1200	GA..K.1325-1	1	750



### mittiger Griff Sitz

FFB min/max	Getriebe		SB Positionen
460 - 800	GA..M.800		--
800 - 1050	GA..M.1050-1	1	127
1051 - 1300	GA..M.1400-1	1	127
1301 - 1200	GA..M.1400-1	1	127

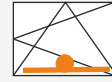

## Getriebe Verriegelungsabstand 700 mm

### konstanter Griff Sitz

FFB min/max	Getriebe		SB Positionen
460 - 700	GA..K.710		--
701 - 850	GA..K.945-1		385
851 - 1100	GA..K.1100-1		500
1101 - 1325	GA..K.1325-2	1	385 750



### mittiger Griff Sitz

FFB min/max	Getriebe		SB Positionen
460 - 800	GA..M.800		--
800 - 1050	GA..M.1050-1		127
1051 - 1200	GA..M.1400-2	1	-223 127

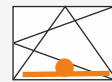

### Oberschiene

FFB min/max			SB Positionen
460 - 1200	OSx.EG.xxx	-	-
866 - 1115	+MK.250-1	1	250
1115 - 1200	+MK.500-1	1	500



### Seitlich

FFB min/max	Mitten verriegelung		SB Positionen Band-	Öffnungsseite
711 - 960	MK.250-1	2	250	230
961 - 1210	MK.500-1	2	500	470
1211 - 1460	MK.750-1	2	750	720
1211 - 1460	2x MK.500-1	2	1000	970
1461 - 1710	MK.750-1	2	750	720
	+ MK.500	+2	1250	1220
1711 - 2210	MK.750-1	2	750	720
	+ MK.750	+2	1250	1220







**Aug. Winkhaus GmbH & Co. KG**

August-Winkhaus-Straße 31  
D-48291 Telgte  
T +49 (0) 25 04-921-0  
F +49 (0) 25 04-921-340

[www.winkhaus.de](http://www.winkhaus.de)  
[fenstertechnik@winkhaus.de](mailto:fenstertechnik@winkhaus.de)