

Blendrahmenverbreiterungen • Outer frame extensions
 Elargisseurs de dormant • Prolongadores de marco

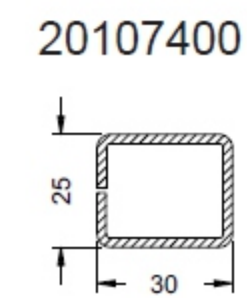

Basisprofile • Base profiles
Profils de base • Perfiles de base

18478...

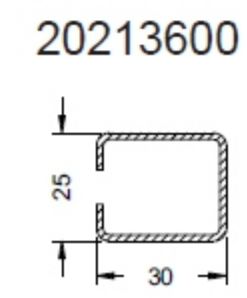
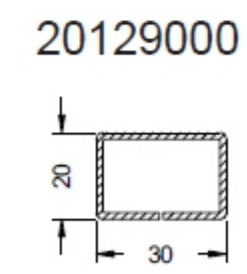
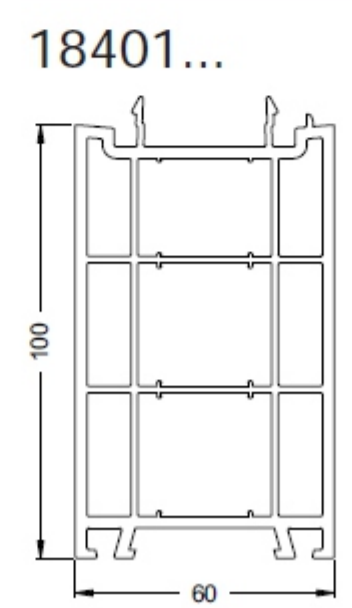
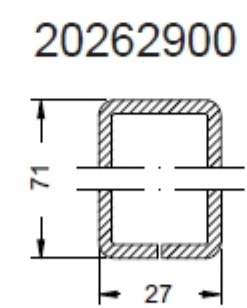
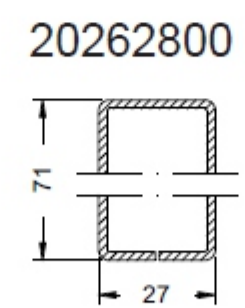
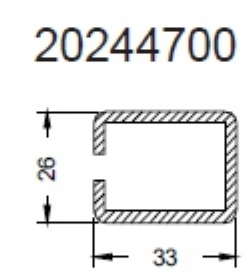
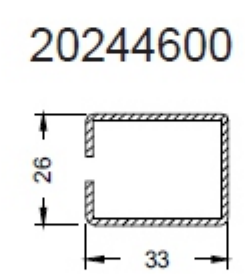
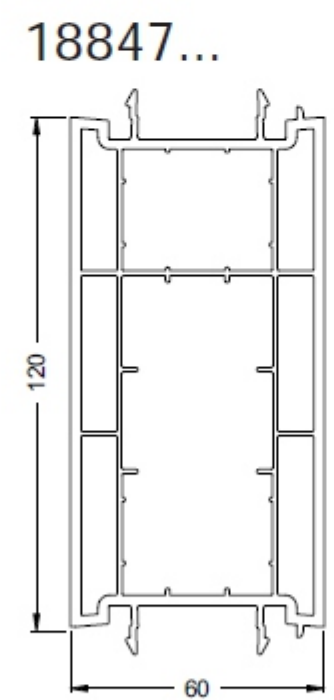
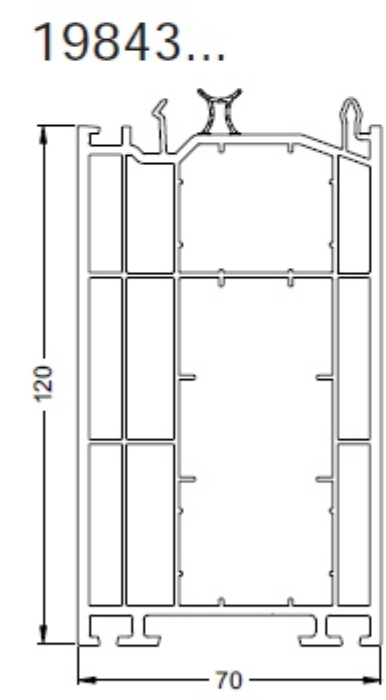
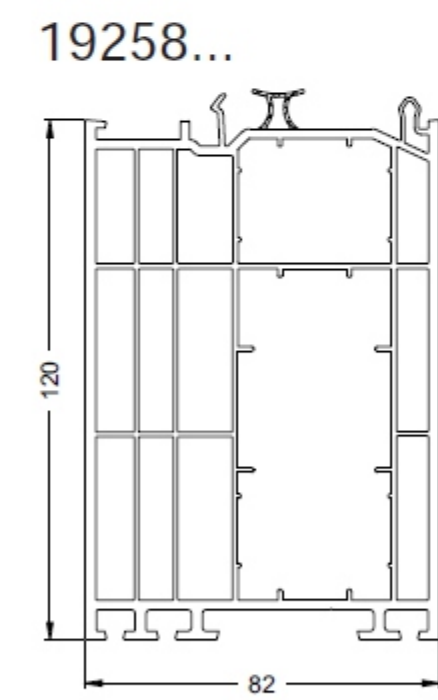
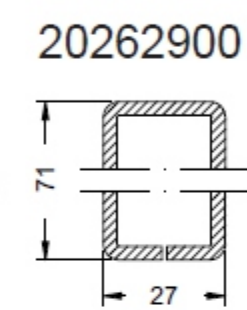
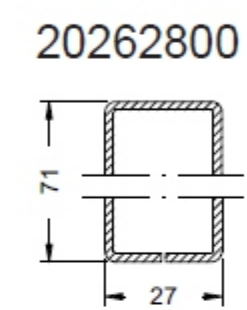
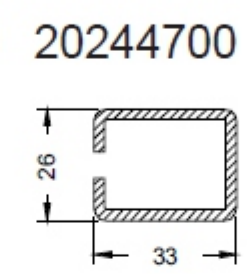
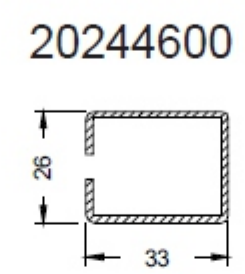
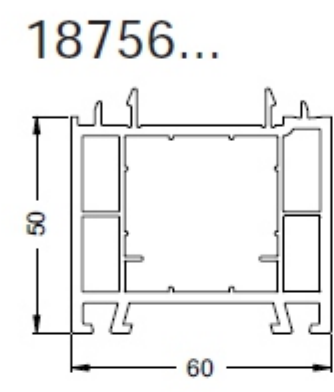
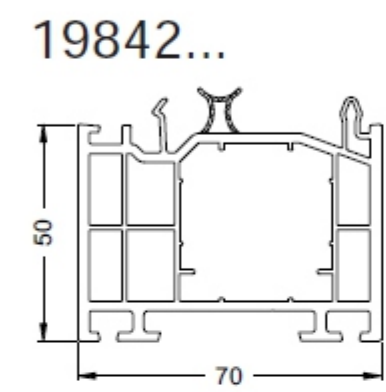
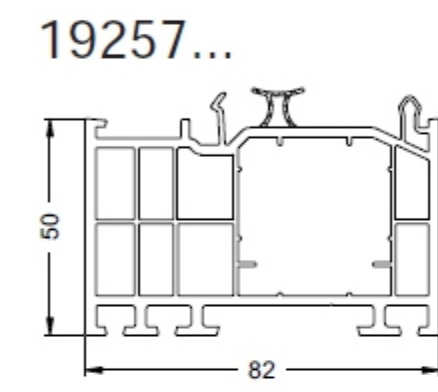
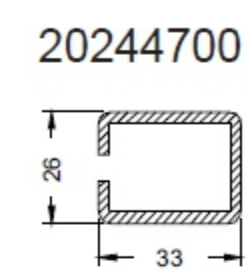
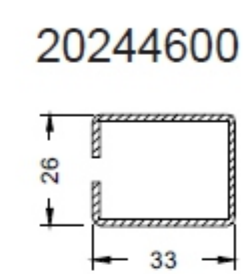
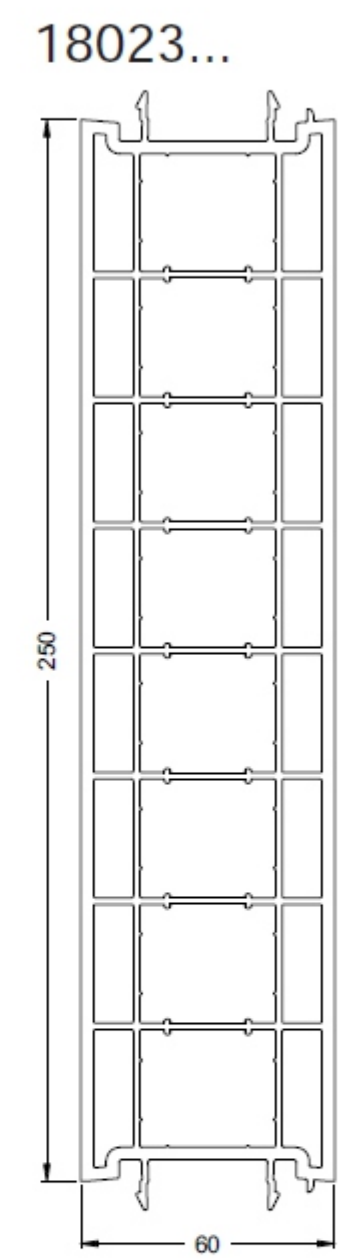
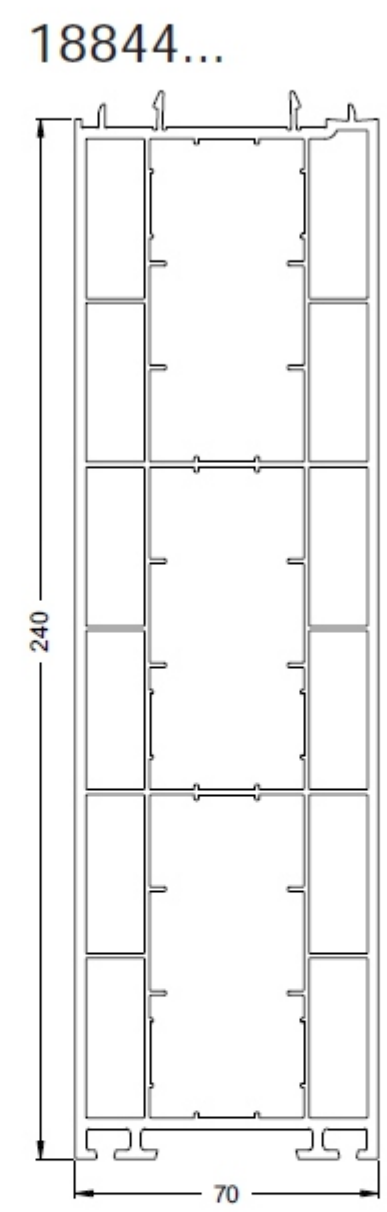
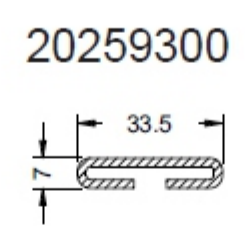
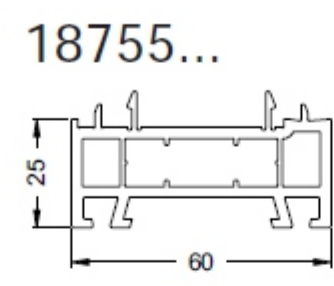
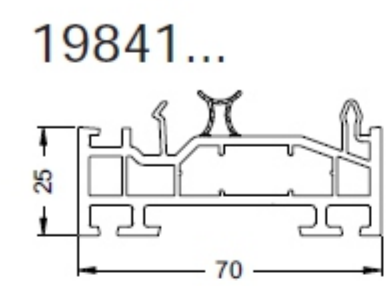
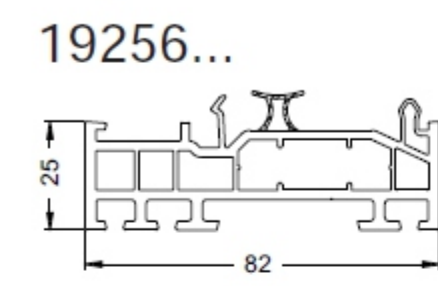
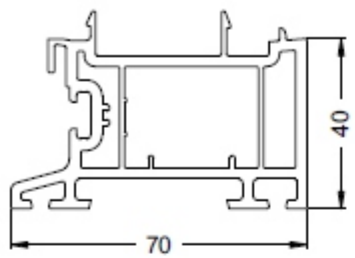

20129000

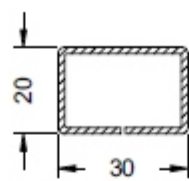

18076...

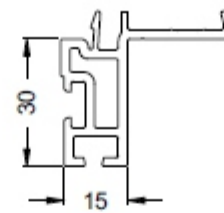

18033...

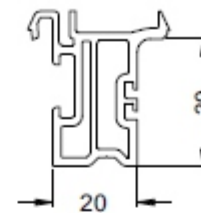

18441...

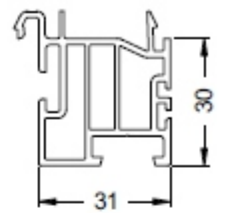

18477...

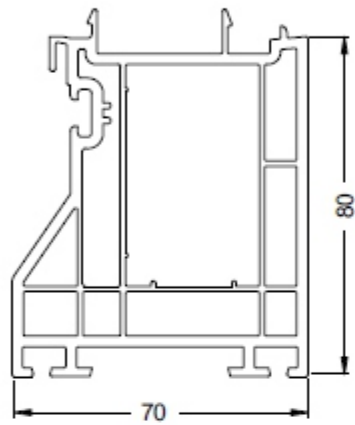

20101600

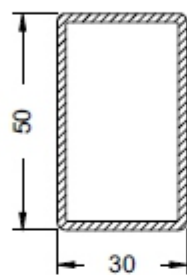

20105600

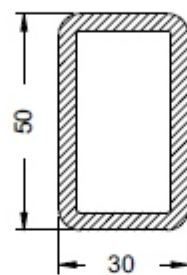

18299...

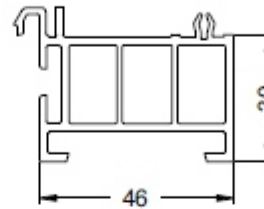

18479...

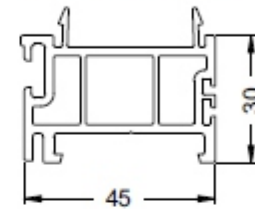

19197...

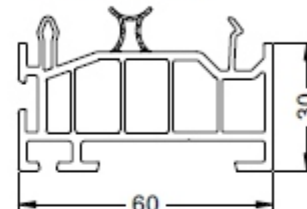

18274...

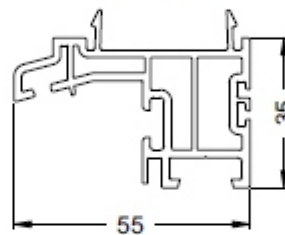

18674...

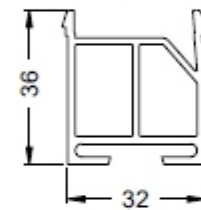

19213...

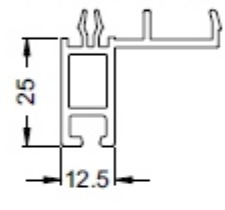

17820...

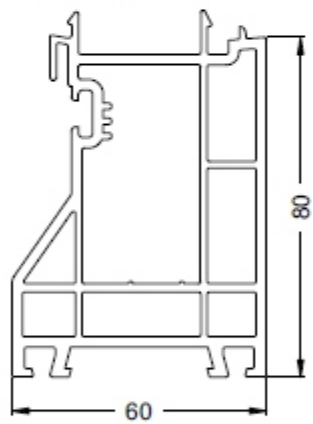

20101500

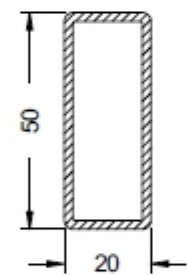

19214...

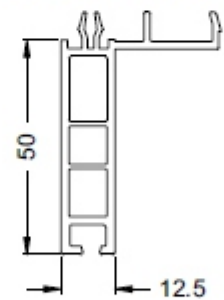

18474...

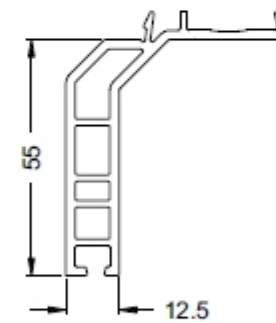

18404...

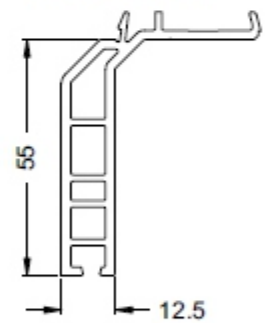

18896...

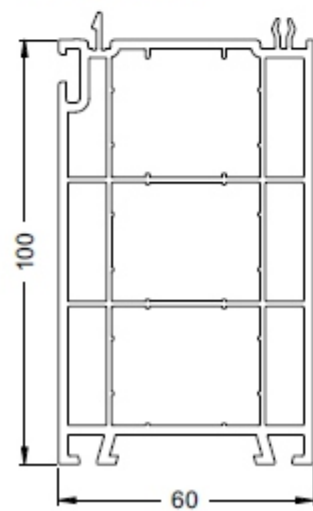

20244600

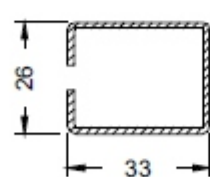

20244700

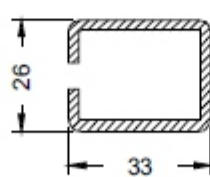

18759...

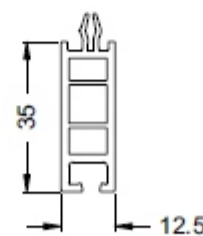

18769...

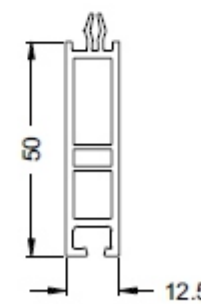

18054...

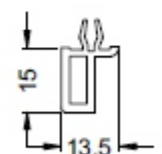

18839...

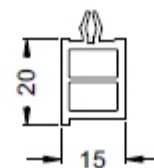

19051...

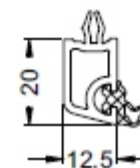

Fensterbankprofile • Window sill profiles
Profilés de bavette • Perfiles de la repisa de la ventana

18439...

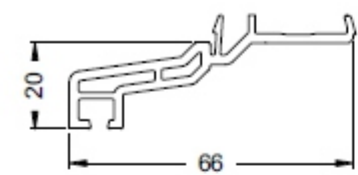

17295...

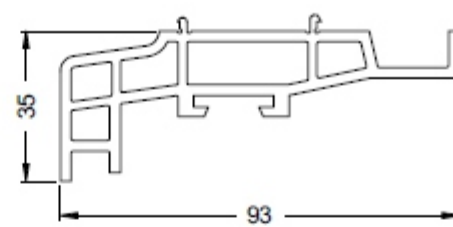

17788...

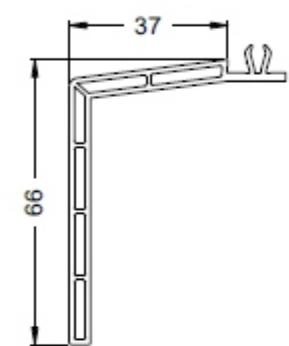

17607...

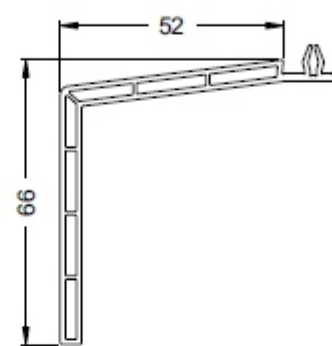

18273...

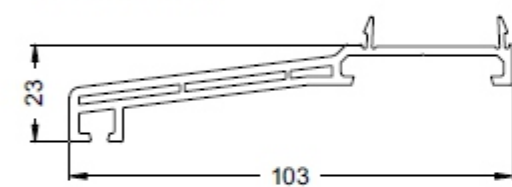

18391...

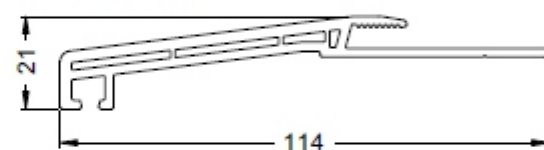

19019...

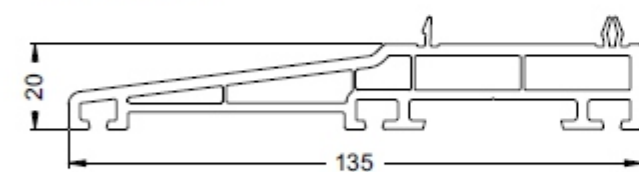

17112...

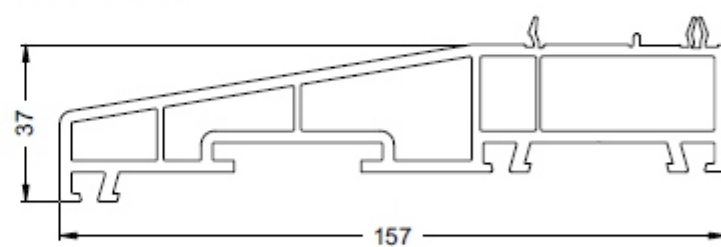

18791...

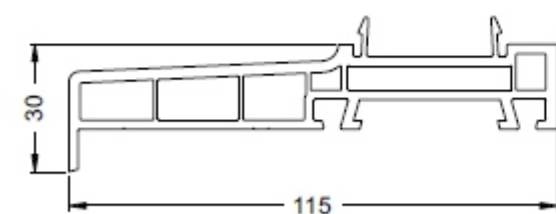

18676...

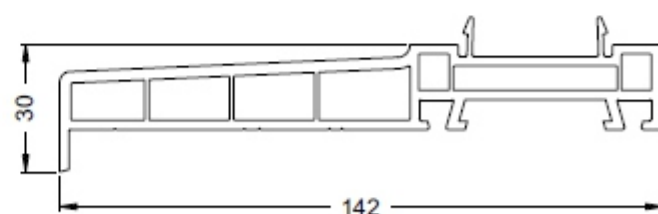

18675...

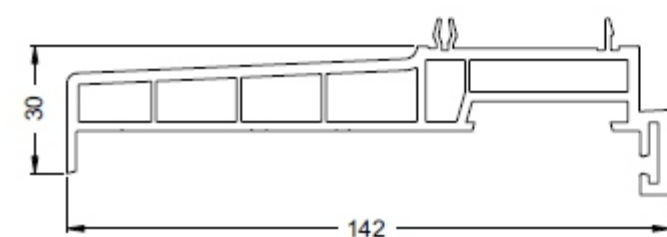

17609...



18423...

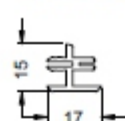

19212...

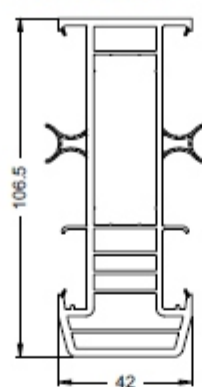

19211...

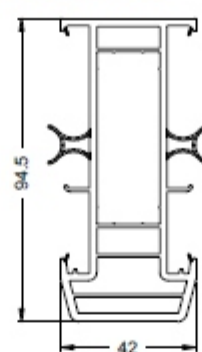

19206...

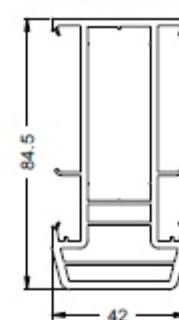

20268700

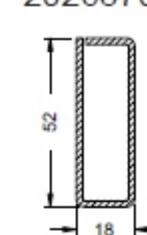

20269100

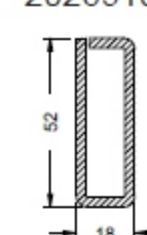

19150...

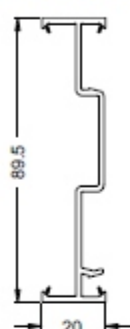

19160...

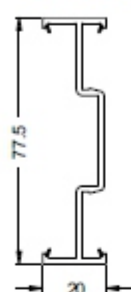

18489...

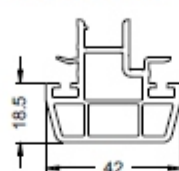

18490...

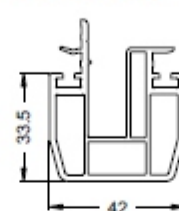

20103600

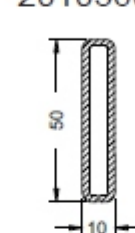

20260000

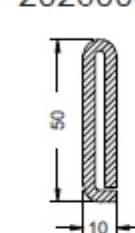

20264000

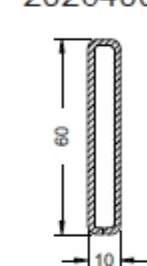

20262700

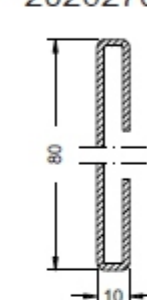

17066...

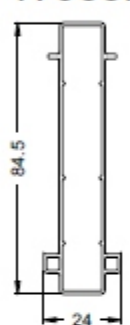

20262700

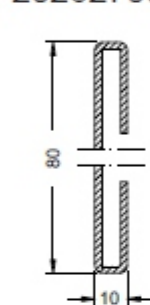

20264100

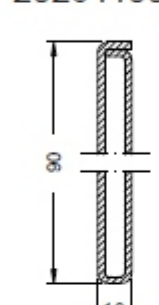

19052...

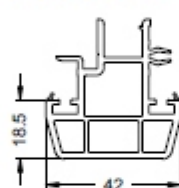

20236800

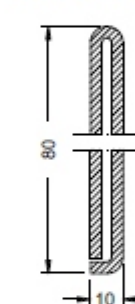

20264100

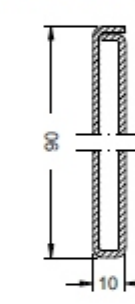

20260100

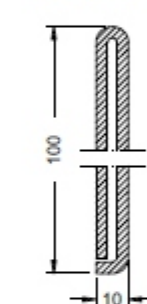

19190...

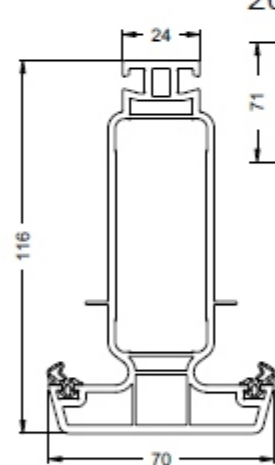

20262800

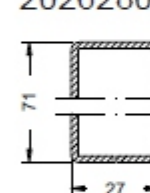

20262900

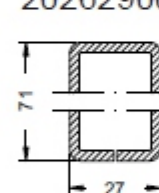

18485...

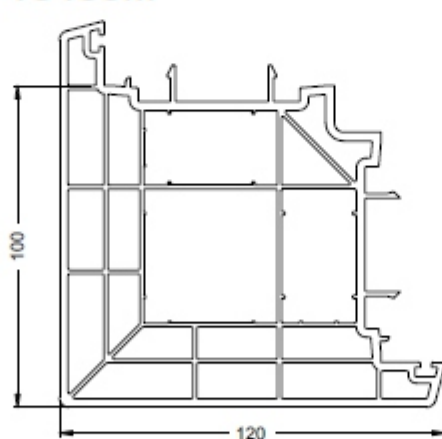

20121000

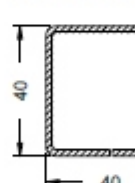

20260000

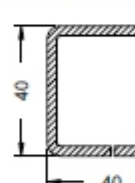

20121100

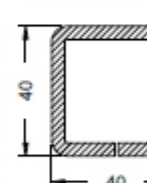

20101900

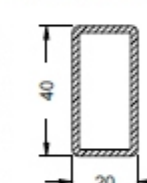

17889

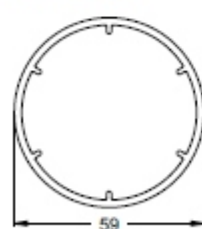

20245100



18579...

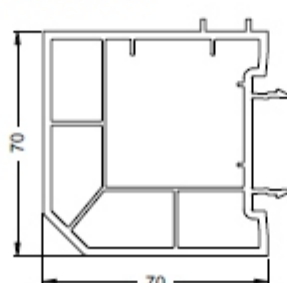

18379...

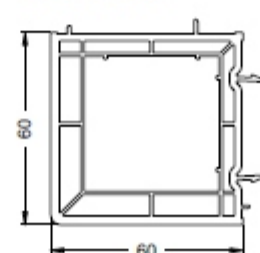

20121000

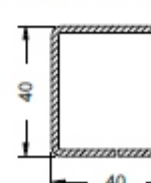

20260000

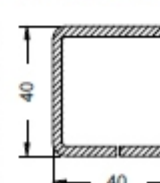

20121100

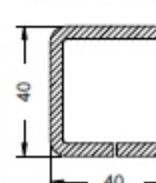

18493

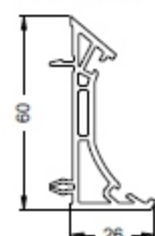

Wetterschenkel und Trittschutzprofile • Drip bar and threshold profiles

Jets d'eau et profilés d protection de seuil • Vierteaguas y perfiles de tapa

18375...

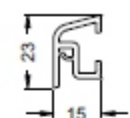

17547...

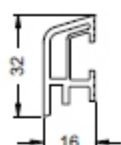

11499700

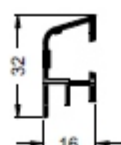

17494...

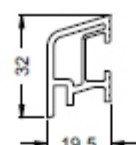

11394900



11496700

11496710

11496770

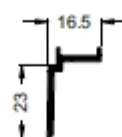

11499610

11499600

11499670

11499660

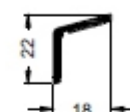

11399400

11399410

11399470

11399460

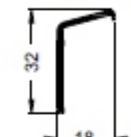

19194...

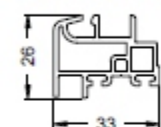

13163300

13163390

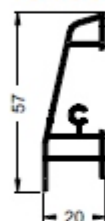

13163500

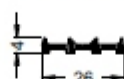

11499410

11499400

11499470

11499460

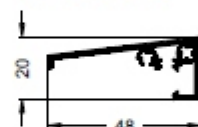

11499510

11499500

11499570

11499560

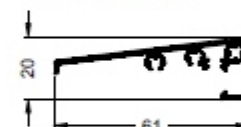

13168660

13168600

13168670

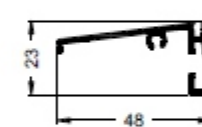

13162300

13162310

13162370

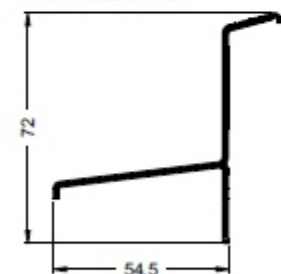

11395400

11395410

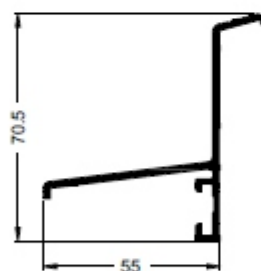

11394400

11394410

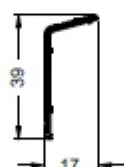

13296700

13296760

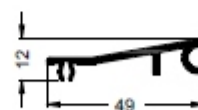

11399300

11399310

11399360

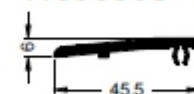

11499260

11499270

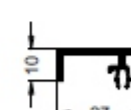

13298100



13295200

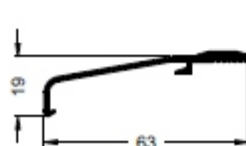

11800500

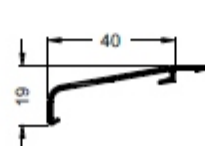

11550100

11550160

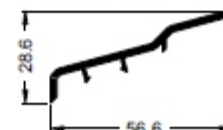

11550200

11550260

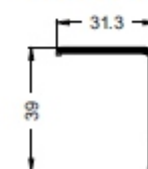

Flachleisten- und Winkelprofile • Flat bar and angled profiles

Profilés de petits-bois plats et d'équerre • Perfiles de listón plano y perfiles angulares

17710...



18788...

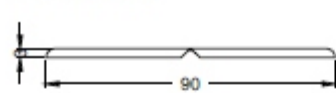

18781...

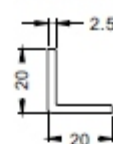

18782...

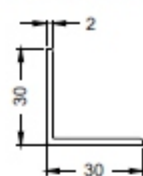

18737...



17172...

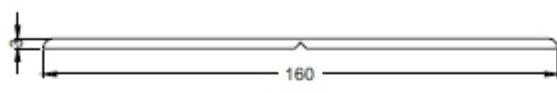

18783...

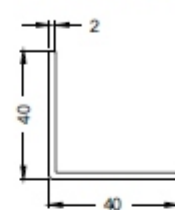

17170...

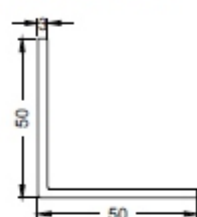

17708...

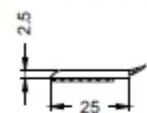

17114...

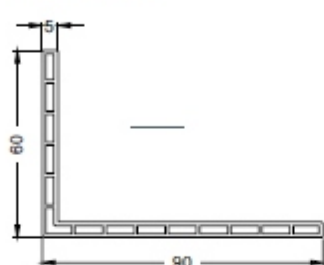

18784...

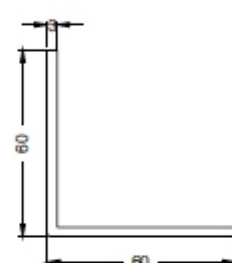

17171...



18402...

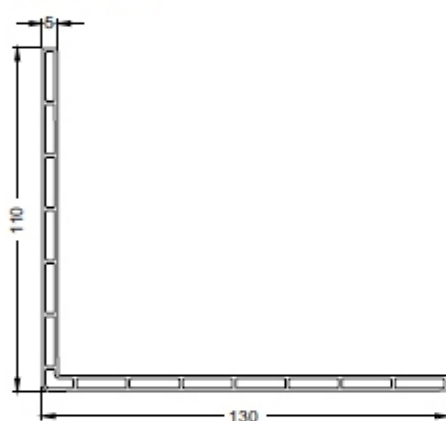

17164...



18475...

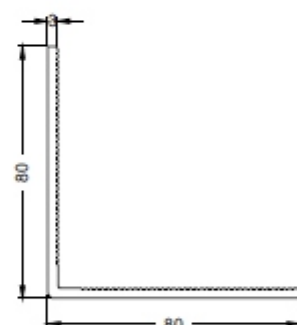

17775...

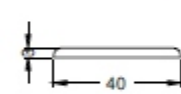

18397...

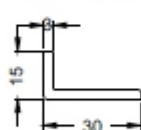

18398...

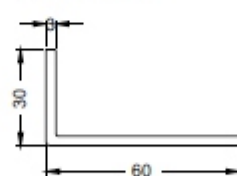

18785...

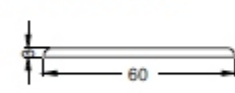

13165710

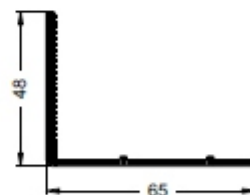

18787...

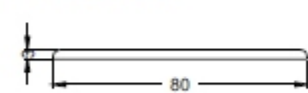

18399...

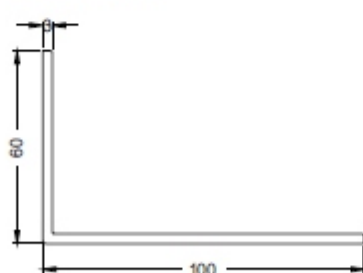

17165...



11394200

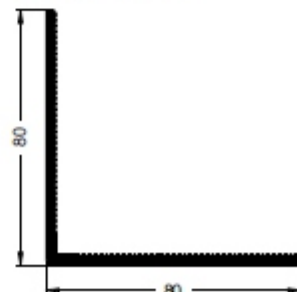

17283...

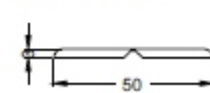

18010...

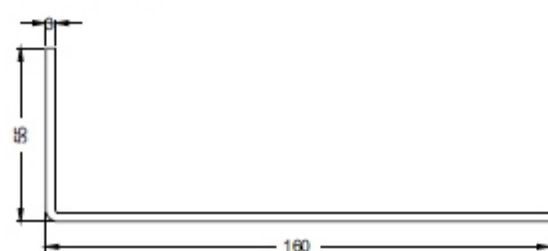

18786...

