



Bestellkatalog
Order Manual

Kunststoff-Systeme

Schüco Living Variant

PVC-U systems

Schüco Living Variant

Hinweise zur Nutzung des Katalogs

Diese Broschüre ist eine Bestell- und Verkaufsunterlage für das System Schüco LivIng Variant.
Sämtliche Bestellinformationen sind enthalten.
Fertigungsinformationen werden in den entsprechenden Fertigungsunterlagen zur Verfügung gestellt.

PVC-, Stahl- und Aluminiumprofile werden in Längen von 6 m geliefert. Alle Ausnahmen sind auf den jeweiligen Seiten des Kataloges gekennzeichnet.

Alle Artikelnummern sind 8-stellig.
Bei PVC-Profilen geben die letzten drei Ziffern die Farbausführung an, z.B. 1 8596 160.
Üblicherweise werden in unseren Katalogen nur die ersten fünf Stellen der Artikelnummer eines Profils angegeben. Den entsprechenden Farbcode und die Verfügbarkeit können der Folierungsübersicht entnommen werden.

Es ist zu beachten, dass alle angegebenen Farben Schüco-Farben entsprechen.

weiß : ähnlich RAL 9016
schwarz : ähnlich RAL 9005
cremeweiß : ähnlich RAL 9001
braun : ähnlich RAL 8014
karamell : ähnlich RAL 8001
grau : ähnlich RAL 7035
dunkelgrau : ähnlich RAL 7015

Aluminiumprofile liefern wir in roher, eloxierter oder farbbeschichteter Ausführung.
Bei der Bestellung ist die gewünschte Oberflächenveredelung gemäß RAL-Farbfächer anzugeben.

Instructions for using the manual

This brochure constitutes order and sales documentation for the Schüco LivIng Variant System.
All of the order information is included.
Fabrication information is provided in the corresponding fabrication documentation.

PVC, steel and aluminium profiles are supplied in 6 m lengths. Any exceptions to this are indicated on the relevant pages of the manual.

All article numbers have 8 digits. For PVC profiles, the last three digits indicate the colour design, e.g. 1 8596 160.

As a rule, only the first five digits of a profile article number are indicated in our manuals. The corresponding colour code and availability can be found in the foiling overview.

It must be ensured that all specified colours match Schüco colours.

White: similar to RAL 9016
Black: similar to RAL 9005
Cream white: similar to RAL 9001
Brown: similar to RAL 8014
Caramel: similar to RAL 8001
Grey: similar to RAL 7035
Dark grey: similar to RAL 7015

Aluminium profiles are supplied either in mill finish, anodised or colour-coated. When ordering, the required surface finish must be indicated as per the RAL colour charts.

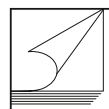

Iconübersicht
Icon overview

Iconübersicht

Icon overview



siehe Seite
See page



Statische Werte in cm⁴
Structural values in cm⁴



Profilwandstärke
Profile wall thickness



Lagerlänge
Stock length



Farbe
Colour



Ansichtsbreite des Profils
Face width of the profile



Klebeflügel
Vent frame for adhesive vent



max. Glasgewicht je Flügel
Max. glass weight per vent



Verpackungseinheit
Packing unit

Stk. = Stück ▪ Quantity
m = Meter ▪ Metre(s)
m* = Meter auf Mehrwegspule ▪ Metres on reusable spool
P. = Paar ▪ Pair(s)



Infos, Tipps und Ratschläge
Information, tips and advice



Hinweis Achtung
Important note



Glasdicke
Glass thickness



Graue Dichtung
Grey gasket



Schwarze Dichtung
Black gasket



Lagerprofil entsprechend Foliensortiment
Stock profile in accordance with range of foils



Grundkörperfarbe weiß
Colour of base material White



Grundkörperfarbe cremeweiß
Colour of base material Cream white

Inhalt
Contents

- 03 Systemeigenschaften
System features
- 29 Profile
Profiles
- 71 Zubehör
Accessories
- 89 Foliensortiment
Foil range
- 99 Profilübersicht Schüco LivIng Variant
Overview of Schüco LivIng profiles Variant

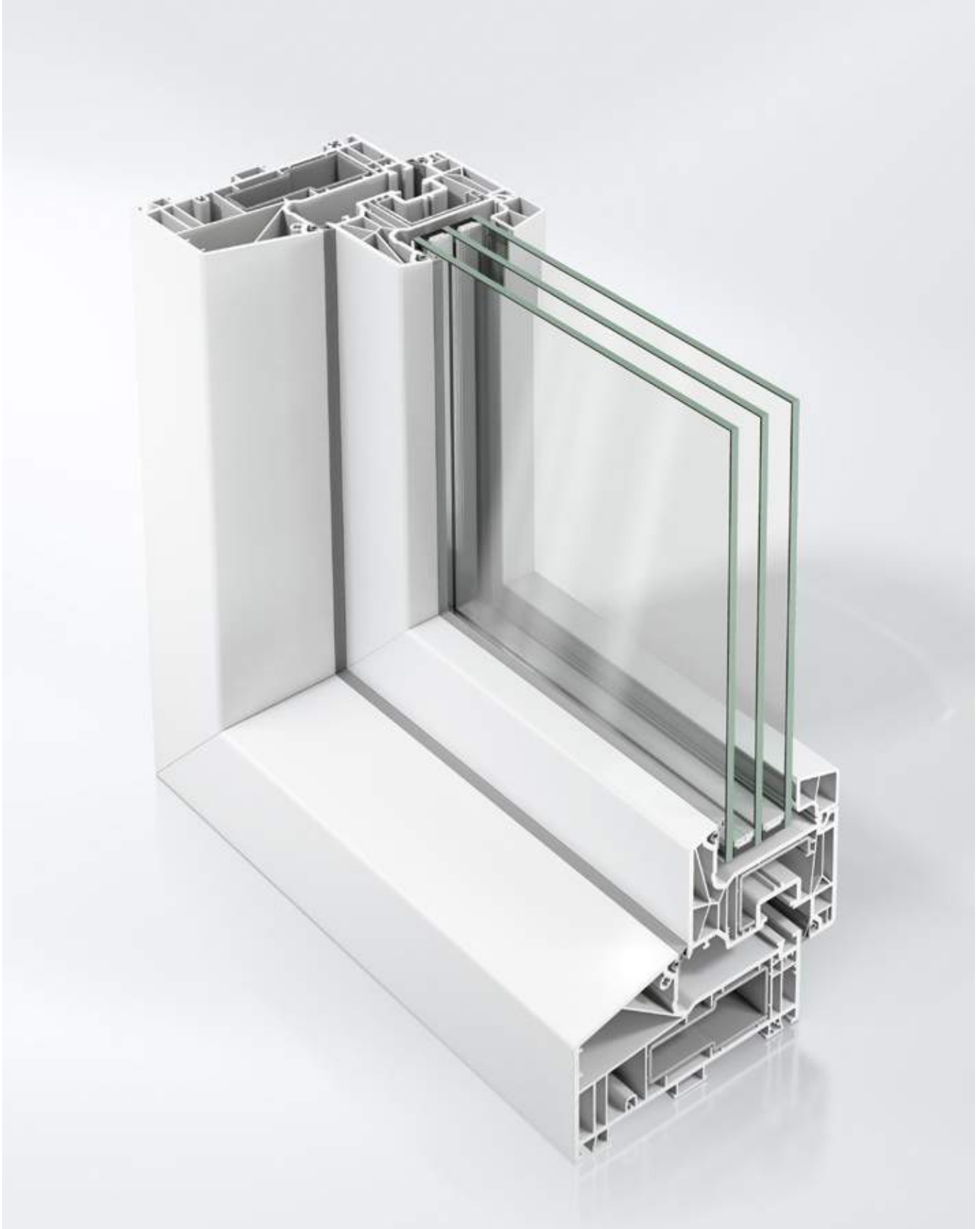

Schüco Liv**Ing** Variant — Systemeigenschaften
Schüco Liv**Ing** Variant — System features

Systemeigenschaften
System features

03

- 04 Produktvorteile
Product benefits
- 08 Systemschnitte
System section details
- 18 Elementtypenübersicht
Overview of unit types
- 20 Maximale Flügelgrößen
Maximum vent sizes
- 22 Eckfestigkeit
Corner stability

Produktvorteile Product benefits

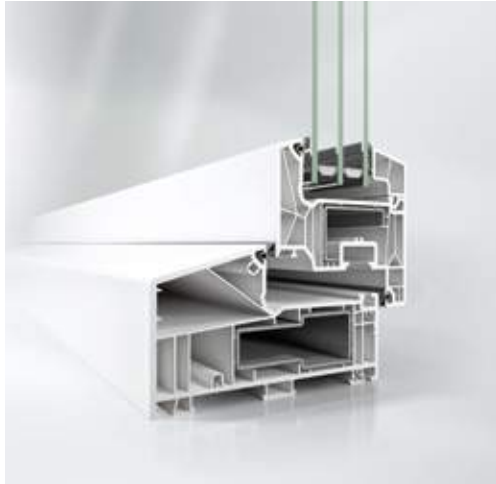

Schüco LivIng Variant

Das Kunststoff-System Schüco LivIng Variant ist ein innovatives 6- bzw. 7-Kammer-System auf Basis des Systems Schüco LivIng und somit komplett systemkompatibel.

The Schüco LivIng Variant PVC-U system is an innovative 6- resp. 7-chamber system based on the Schüco LivIng system and thus fully compatible with it.

Technische Informationen Technical information	Variant
Abmaße ■ Dimensions	
Bautiefe Blendrahmen Basic depth of outer frame	120 mm
Bautiefe Flügelrahmen Basic depth of vent frame	82 mm
Mögliche Verglasungsstärke Possible glazing thickness	24 mm – 52 mm
Prüfungen und Normen ■ Tests and standards	
Wärmedämmung nach DIN EN 12412-2* Thermal insulation in accordance with DIN EN 12412-2*	$U_f = \text{bis zu } 1,1 \text{ W/(m}^2\text{K)}$ $U_f = \text{up to } 1,1 \text{ W/(m}^2\text{K)}$
Einbruchhemmung nach SKG** Burglar resistance in accordance with SKG**	SKG Klasse 2 SKG class 2
Luftdurchlässigkeit nach DIN EN 12207 (Klasse) Air permeability in accordance with DIN EN 12207 (Class)	4
Schlagregendichtheit nach DIN EN 12208 (Klasse) Watertightness in accordance with DIN EN 12208 (Class)	9A
Widerstandsfähigkeit bei Windlast DIN EN 12210 (Klasse)* Resistance to wind load in accordance with DIN EN 12210 (Class)*	C5 / B5
Mechanische Beanspruchung nach DIN EN 13115 (Klasse) Mechanical loading in accordance with DIN EN 13115 (Class)	4
Dauerfunktion nach DIN EN 12400 (Klasse) Resistance to repeated opening and closing in accordance with DIN EN 12400 (Class)	2
Bedienkräfte nach DIN EN 13115 (Klasse) Operating forces in accordance with DIN EN 13115 (Class)	1
Tragfähigkeit von Sicherheitsvorrichtungen Load-bearing capacity of safety devices	Anforderung erfüllt Requirement met

* Profilabhängig

* Dependent on profile

** in Verbindung mit SKG-zertifizierten Beschlägen

** In conjunction with SKG-certified fittings



☰	Produktvorteile	Product benefits
	<ul style="list-style-type: none"> ▪ Speziell für den niederländischen Markt wurde mit den geometrisch innovativen Block-Blendrahmen die landestypische Holzfensteroptik nachgestellt ▪ Farbliche Gestaltung der Profile durch weiße und cremeweiße Grundkörperfarben und zusätzlich eine hohe Auswahl an Holz- und Uni-Dekorfolien möglich ▪ Eine, auch im kritischen Eckbereich weiche, umlaufend geschlossene Dichtungsebene gewährt die maximale Funktionssicherheit ▪ Hohe Funktionssicherheit durch 6 mm Flügelüberschlag außen und 8 mm innen ▪ Hohe Toleranzaufnahme durch 5 mm Dichtungsspaltmaß zwischen Blend- und Flügelrahmen ▪ Glasleistenhöhe von 25 mm für erhöhten Glaseinstand ▪ Werkseitig maschinell eingerollte, hochwertige EPDM-Funktionsdichtungen, schweißbar ▪ Wanddicken nach RAL-GZ/716 und DIN EN 12608 ▪ Vollständig recyclebar 	<ul style="list-style-type: none"> ▪ Specially for the Dutch market: the block outer frames and their innovative shape reproduce the typical timber window look ▪ Profiles can be coloured using white and cream-white base material and an additional large selection of woodgrains and single colour decorative foils ▪ A continuous, closed drainage level that is soft even in the critical corner area ensures maximum functional performance ▪ High level of functional reliability with 6 mm vent overlap outside and 8 mm inside ▪ 5 mm gasket clearance takes up tolerances between outer and vent frames ▪ Glazing bead height of 25 mm for increased glass edge cover ▪ High-quality EPDM functional gaskets machine-rolled in the factory, can be welded ▪ Wall thicknesses in accordance with RAL-GZ/716 and DIN EN 12608 ▪ Fully recyclable

Produktvorteile	Product benefits
<p>Energie</p> <ul style="list-style-type: none"> ▪ Profilkonstruktion mit optimierter Kammergeometrie und einer Rahmenbautiefe von 82 mm / 120 mm für hervorragende thermische Isolation ▪ U_f-Werte von bis zu 1,1 W/(m²K) ▪ Flügelüberschlag von 8 mm minimiert Wärmeverluste ▪ Erhöhter Glaseinstand durch Glasleistenhöhe von 25 mm garantiert geringen Wärmeverlust im Bereich des Glasrandverbunds ▪ 3-fach-Verglasungen mit einer Glasstärke bis 52 mm möglich 	<p>Energy</p> <ul style="list-style-type: none"> ▪ Profile construction with optimised chamber geometry and a basic frame depth of 82 mm / 120 mm for excellent thermal insulation ▪ U_f values of up to 1.1 W/(m²K) ▪ Vent overlap of 8 mm minimises heat loss ▪ Increased glass edge cover thanks to glazing bead height of 25 mm guarantees minimal heat loss in the glass edge seal area ▪ Triple glazing with a glass thickness of up to 52 mm possible

Isotherme Schüco LivIng Variant

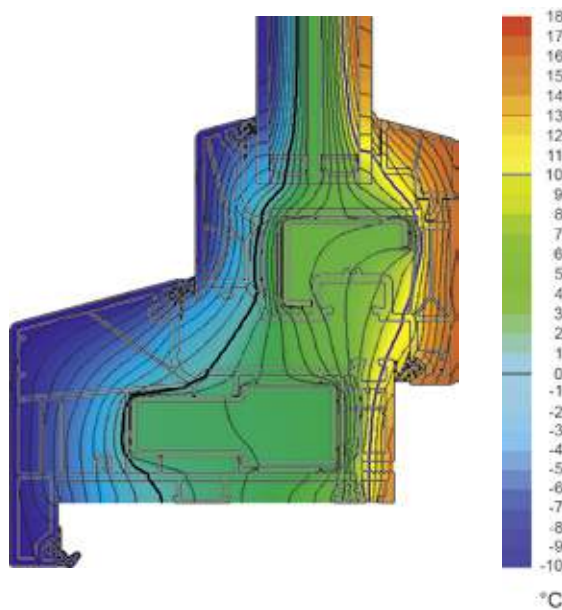

Produktvorteile	Product benefits
<p>Komfort</p> <ul style="list-style-type: none"> ▪ Schmale Ansichtsbreiten sorgen für höchstmöglichen Lichteinfall und unterstreichen die schlanke Optik des Fensters ▪ Hervorragende Schallschutzwerte (je nach Profilkombination und Verglasung sind Schalldämmwerte bis R_{w,p} 47 dB möglich)^① ▪ Glatter Blendrahmenfalz und bündige Glasleisteninnenkanten ermöglichen leichte und problemlose Reinigung der Fenster ▪ Dichtungsspalt von 5 mm gewährleistet ein weiches Schließen der Fenster 	<p>Comfort</p> <ul style="list-style-type: none"> ▪ Narrow face widths ensure maximum light penetration and highlight the slimline look of the window ▪ Excellent sound reduction values (depending on the profile combination and glazing, sound insulation values up to R_{w,p} 47 dB are possible)^① ▪ Smooth outer frame rebate and flush glazing bead inner edges make the windows easy to clean ▪ Gasket clearance of 5 mm ensures the windows close smoothly

① in Vorbereitung
① Pending

 Produktvorteile	Product benefits
Design <ul style="list-style-type: none"> ▪ Die beiden geometrisch innovativen Konturen der Blendrahmen Variant imitieren die typische Holzfensteroptik und ermöglichen somit die optische Renovation von Holzfenstern ▪ Flügelgeometrie in flächenversetzter Optik (Classic) ▪ Auffällige Konturen mit prägnanten Softform-Radien und Schrägen an den Sichtflächen ▪ Alle Profile werden marktspezifisch standardmäßig mit silbergrauen Dichtungen geliefert ▪ Verschiedene Glasleistenkonturen als optisches Gestaltungsmittel ▪ Die bündig sitzenden Dichtungen passen sich optimal in die Fensteroptik ein ▪ Farbliche Gestaltung der Profile durch eine große Auswahl an Unifarben und Holzdekoren möglich 	Design <ul style="list-style-type: none"> ▪ The two geometrically innovative contours of the Variant outer frame imitate the typical timber window look and therefore give the appearance of renovated timber windows ▪ Vent geometry with rebated appearance (Classic) ▪ Striking contours with concise softform radii and sloping exposed faces ▪ All profiles are supplied with silver-grey gaskets as standard ▪ Various glazing bead contours as a design feature ▪ The flush fitting gaskets blend in perfectly with the appearance of the window ▪ Profiles can be coloured with a large selection of single colour and woodgrain decorative foils
Sicherheit <ul style="list-style-type: none"> ▪ Unterschiedliche Verstärkungsprofile im Blend- und Flügelrahmen sorgen je nach statischer Anforderung für höchste Stabilität und Langlebigkeit der Fenster ▪ Ecklagerverschraubung im Flügel erfolgt durch spezielle Schraubkanäle ▪ Beschlagachse von 13 mm ermöglicht den Einsatz von einbruchhemmenden Beschlagteilen ▪ Bei erhöhten Sicherheitsanforderungen ist der Einsatz von Sicherheitsriegelstücken mit Verschraubung in der Stahlarmierung möglich ▪ Glasleistenhöhe von 25 mm für erhöhten Glaseinstand ▪ Erhöhte Bautiefe für mehr Sicherheit und Einbruchschutz 	Security <ul style="list-style-type: none"> ▪ Depending on structural requirements, different reinforcing profiles in the outer and vent frames ensure that the windows are highly robust and durable ▪ Special screw ports for fixing the corner pivot in the vent ▪ The fittings axis of 13 mm allows the use of burglar-resistant fittings components ▪ Where increased security is required, security locking keeps with a screw fixing in the steel reinforcement can be used ▪ Glazing bead height of 25 mm for increased glass edge cover ▪ Increased basic depth for added security and burglar resistance

 Verarbeitungsvorteile	Fabrication benefits
Systemverarbeitung <ul style="list-style-type: none"> ▪ Werkseitig eingerollte, schweißbare EPDM-Dichtungen mit gleichen Querschnitten für Glasanlage- und Anschlagdichtung ▪ Sichtbare oder verdeckte Blendrahmenentwässerung, je nach Bausituation auf mehreren Ebenen möglich ▪ Durch 5 mm Dichtungsspalt zwischen Blend- und Flügelrahmen kann auf das Ausklinken der Flügelanschlagdichtung im Scherenlagerbereich verzichtet werden ▪ Innenliegende Nut für den Anschluss von Zusatzprofilen ▪ Einheitliche Falzhöhe der Profile von 3 mm ▪ Gute Elementstabilität und hohe Verwindungssteifigkeit der Rahmenkonstruktion durch optimale Befestigung über die Schraubkanäle in den Profilen 	System fabrication <ul style="list-style-type: none"> ▪ Weld-on EPDM gaskets rolled in the factory with equal cross sections for glazing and rebate gaskets ▪ Visible or concealed outer frame drainage possible on several levels to suit requirements ▪ Due to the 5 mm gasket clearance between the outer and vent frames, the vent rebate gasket does not need to be notched in the turn/tilt mechanism pivot area ▪ Internal groove for attachment of additional profiles ▪ Uniform 3 mm rebate height of the profiles ▪ High level of stability and resistance to torsion in the frame thanks to optimum fixing via the screw ports in the profiles

Systemeigenschaften

System section details

Schüco LivIng Variant 15°

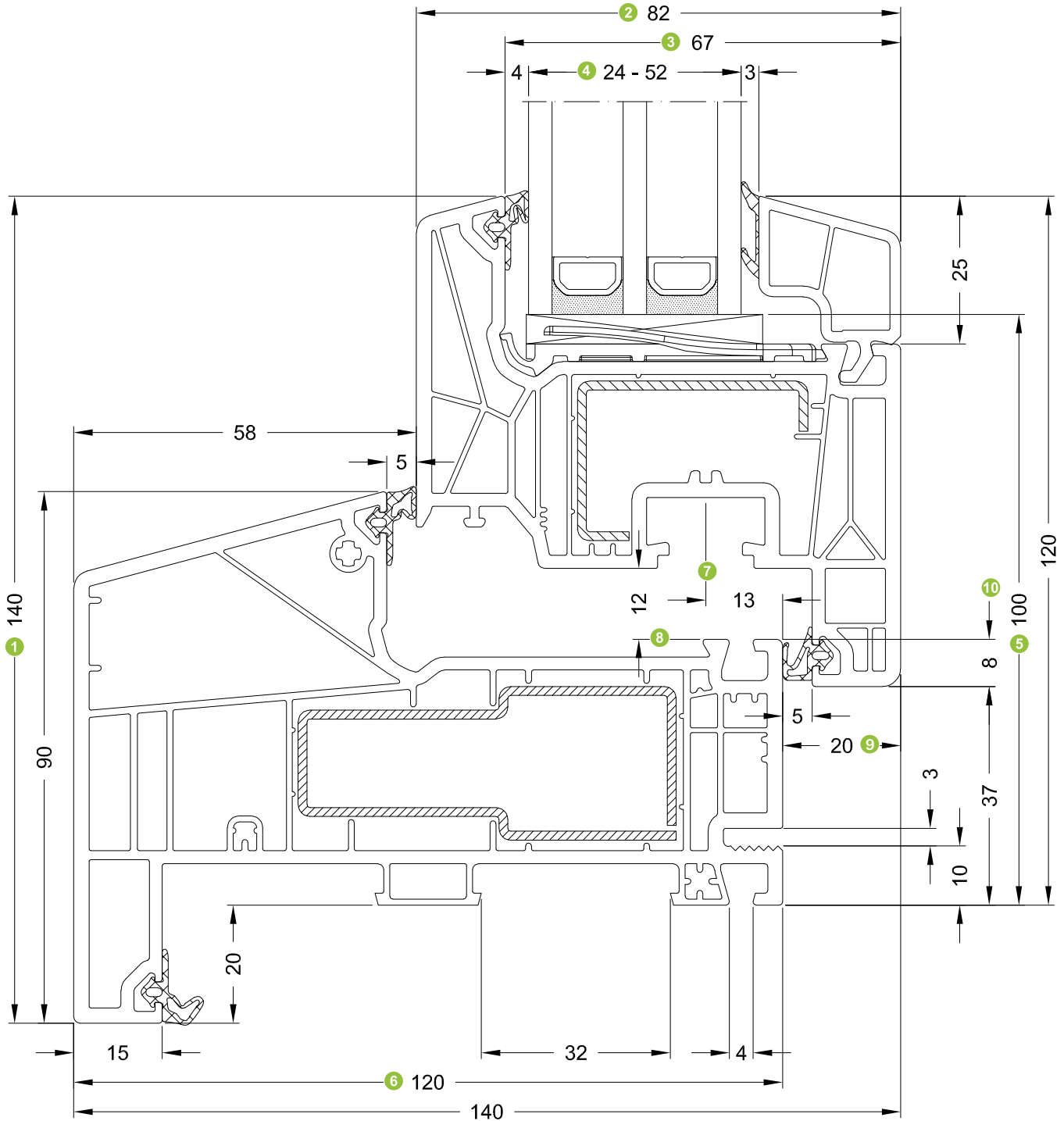

19495...
Blendrahmen 120/90 Variant 15° mit Anschlag und Nut
Variant outer frame 120/90, 15°, with stop and groove

19431...
Flügelrahmen 82/83
Vent frame 82/83

- | | | | |
|---|--|---|--|
| ① | Ansichtsbreite
Face width | ⑥ | Blendrahmen Bautiefe
Basic depth of outer frame |
| ② | Flügelrahmen Bautiefe
Basic depth of vent frame | ⑦ | Achsmaß Beschlag
Axis dimension of fitting |
| ③ | Glasfalzbreite
Glazing rebate width | ⑧ | Falzlufthmaß
Rebate space dimension |
| ④ | Glasdicke
Glass thickness | ⑨ | Aufdeckmaß
Tolerance |
| ⑤ | Glasabzugsmaß
Glass deduction | ⑩ | Flügelüberschlag
Vent overlap |

Schüco LivIng Variant 6°

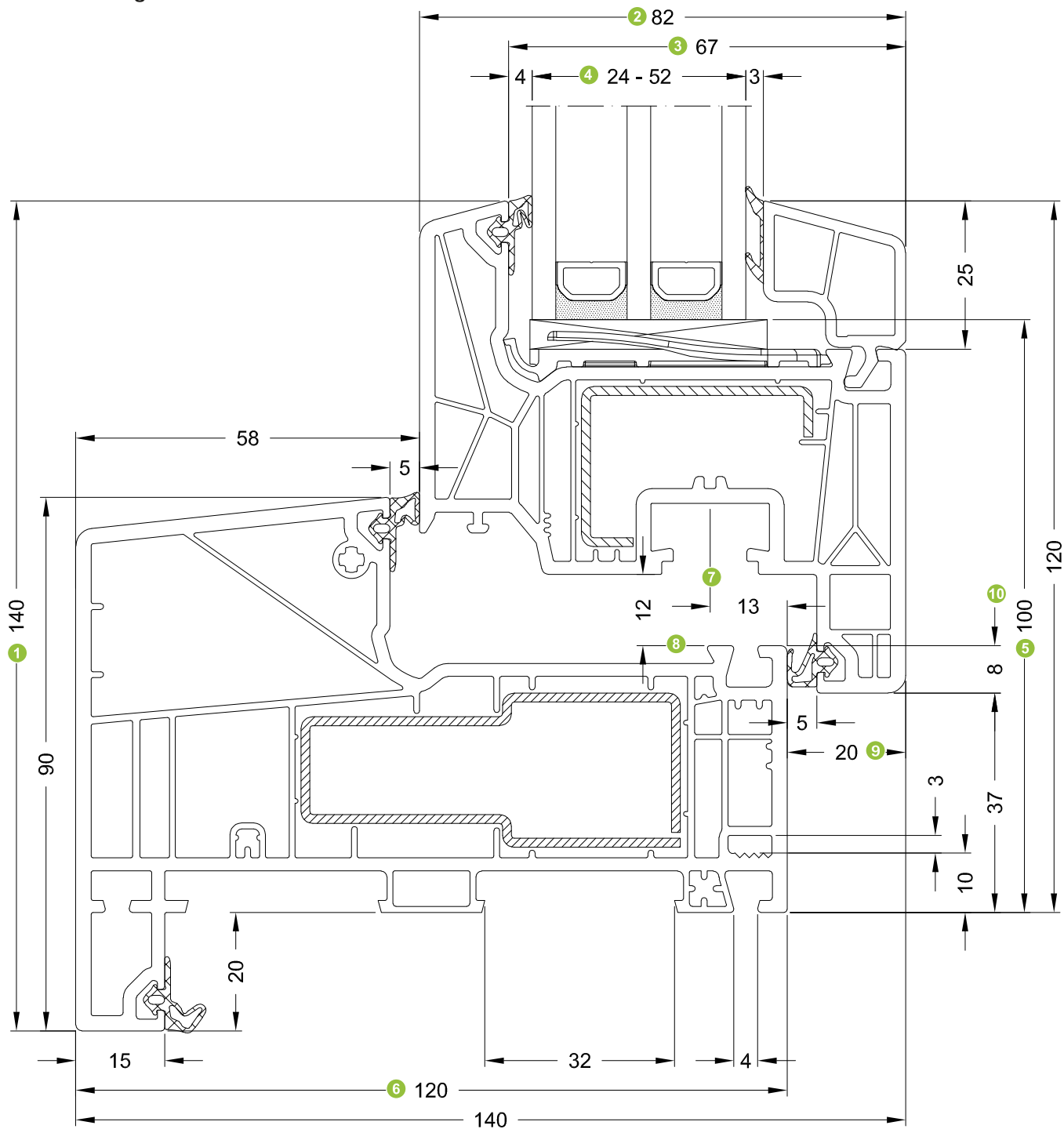

19493...
Blendrahmen 120/90 Variant 6° mit Anschlag
Variant outer frame 120/90, 6°, with stop

19431...
Flügelrahmen 82/83
Vent frame 82/83

- | | | | |
|---|--|----|--|
| 1 | Ansichtsbreite
Face width | 6 | Blendrahmen Bautiefe
Basic depth of outer frame |
| 2 | Flügelrahmen Bautiefe
Basic depth of vent frame | 7 | Achismaß Beschlag
Axis dimension of fitting |
| 3 | Glasfalzbreite
Glazing rebate width | 8 | Falzlufthmaß
Rebate space dimension |
| 4 | Glasdicke
Glass thickness | 9 | Aufdeckmaß
Tolerance |
| 5 | Glasabzugsmaß
Glass deduction | 10 | Flügelüberschlag
Vent overlap |

Schüco LivIng Variant 15°

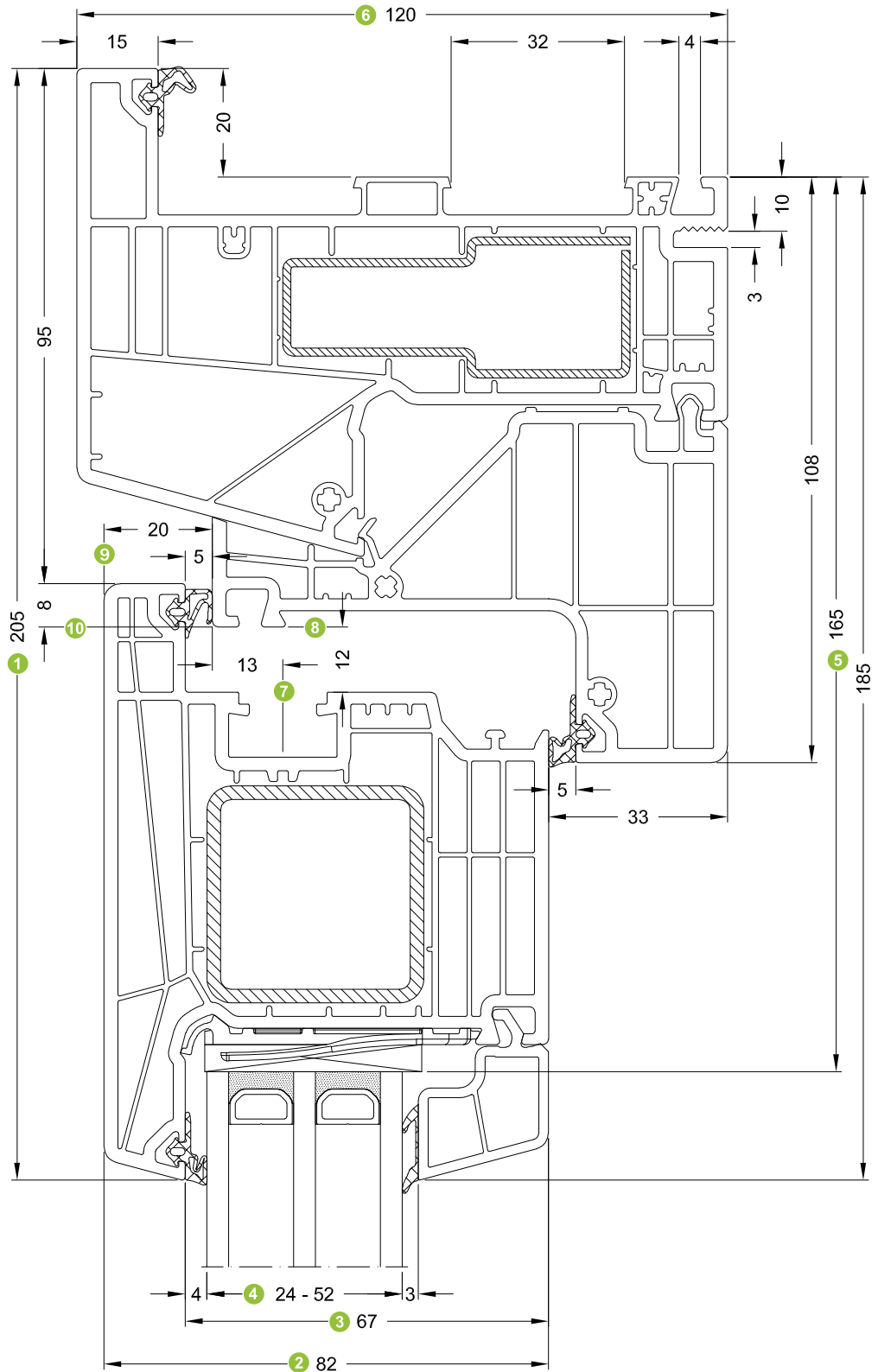

19495...
Blendrahmen 120/90 Variant 15° mit Anschlag und Nut
Variant outer frame 120/90, 15°, with stop and groove

19452...
Flügelrahmen 82/110 nach außen öffnend
Vent frame 82/110, outward-opening

19498...
Adapter-Wechselprofil 95/63 Variant 15°
Variant adapter reverse rebate profile 95/63, 15°

- 1 Ansichtsbreite
Face width
- 2 Flügelrahmen Bautiefe
Basic depth of vent frame
- 3 Glasfalzbreite
Glazing rebate width
- 4 Glasdicke
Glass thickness
- 5 Glasabzugsmaß
Glass deduction
- 6 Blendrahmen Bautiefe
Basic depth of outer frame
- 7 Achsmaß Beschlag
Axis dimension of fitting
- 8 Falzlufmaß
Rebate space dimension
- 9 Aufdeckmaß
Tolerance
- 10 Flügelüberschlag
Vent overlap

Schüco LivIng Variant 6°

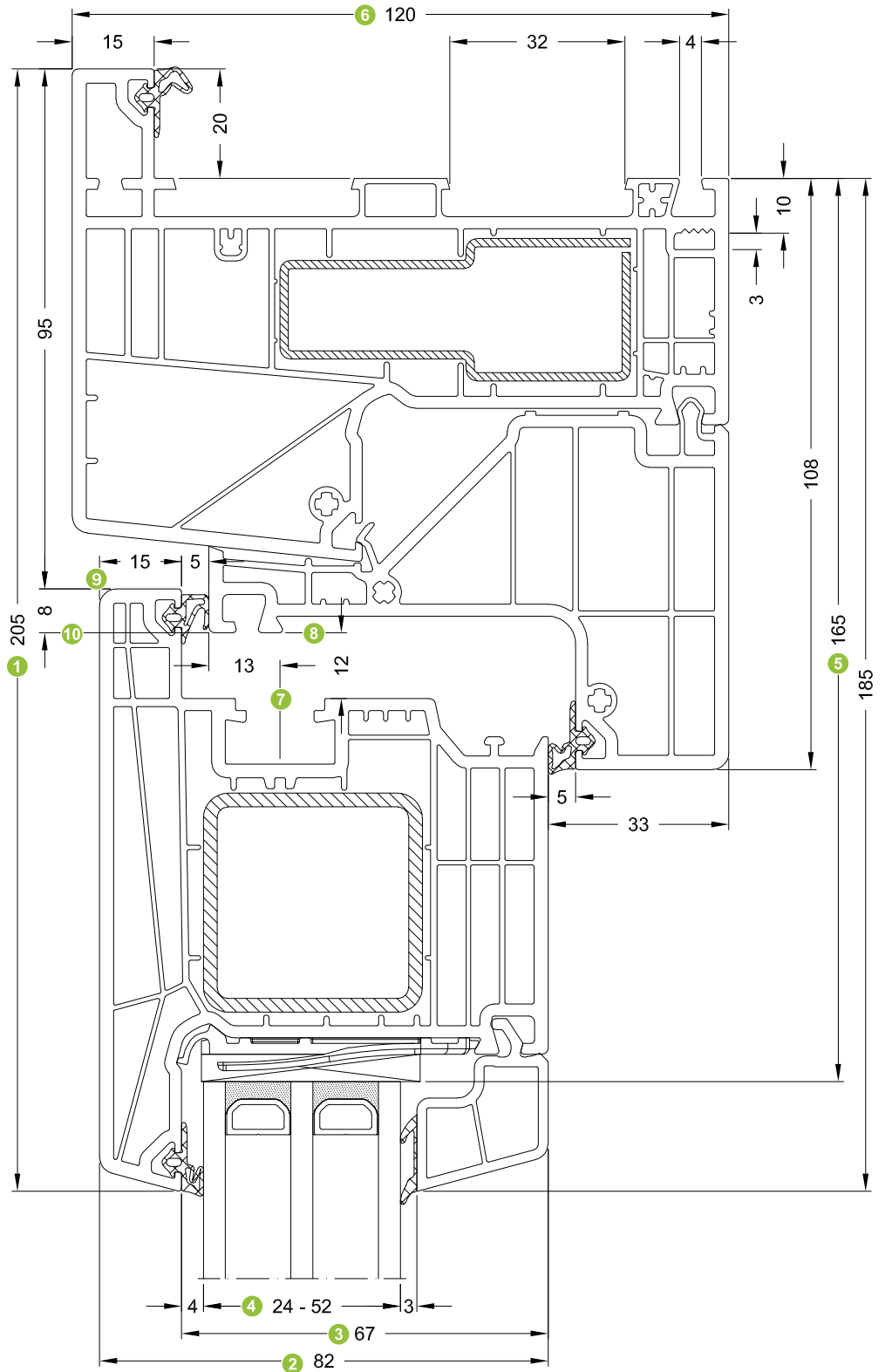

19493...
Blendrahmen 120/90 Variant 6° mit Anschlag
Variant outer frame 120/90, 6°, with stop

19452...
Flügelrahmen 82/110 nach außen öffnend
Vent frame 82/110, outward-opening

19499...
Adapter-Wechselprofil 95/63 Variant 6°
Variant adapter reverse rebate profile 95/63, 6°

- | | | | |
|---|--|---|--|
| ① | Ansichtsbreite
Face width | ⑥ | Blendrahmen Bautiefe
Basic depth of outer frame |
| ② | Flügelrahmen Bautiefe
Basic depth of vent frame | ⑦ | Achismaß Beschlag
Axis dimension of fitting |
| ③ | Glasfalzbreite
Glazing rebate width | ⑧ | Falzlufthmaß
Rebate space dimension |
| ④ | Glasdicke
Glass thickness | ⑨ | Aufdeckmaß
Tolerance |
| ⑤ | Glasabzugsmaß
Glass deduction | ⑩ | Flügelüberschlag
Vent overlap |

Schüco LivIng Variant 15°

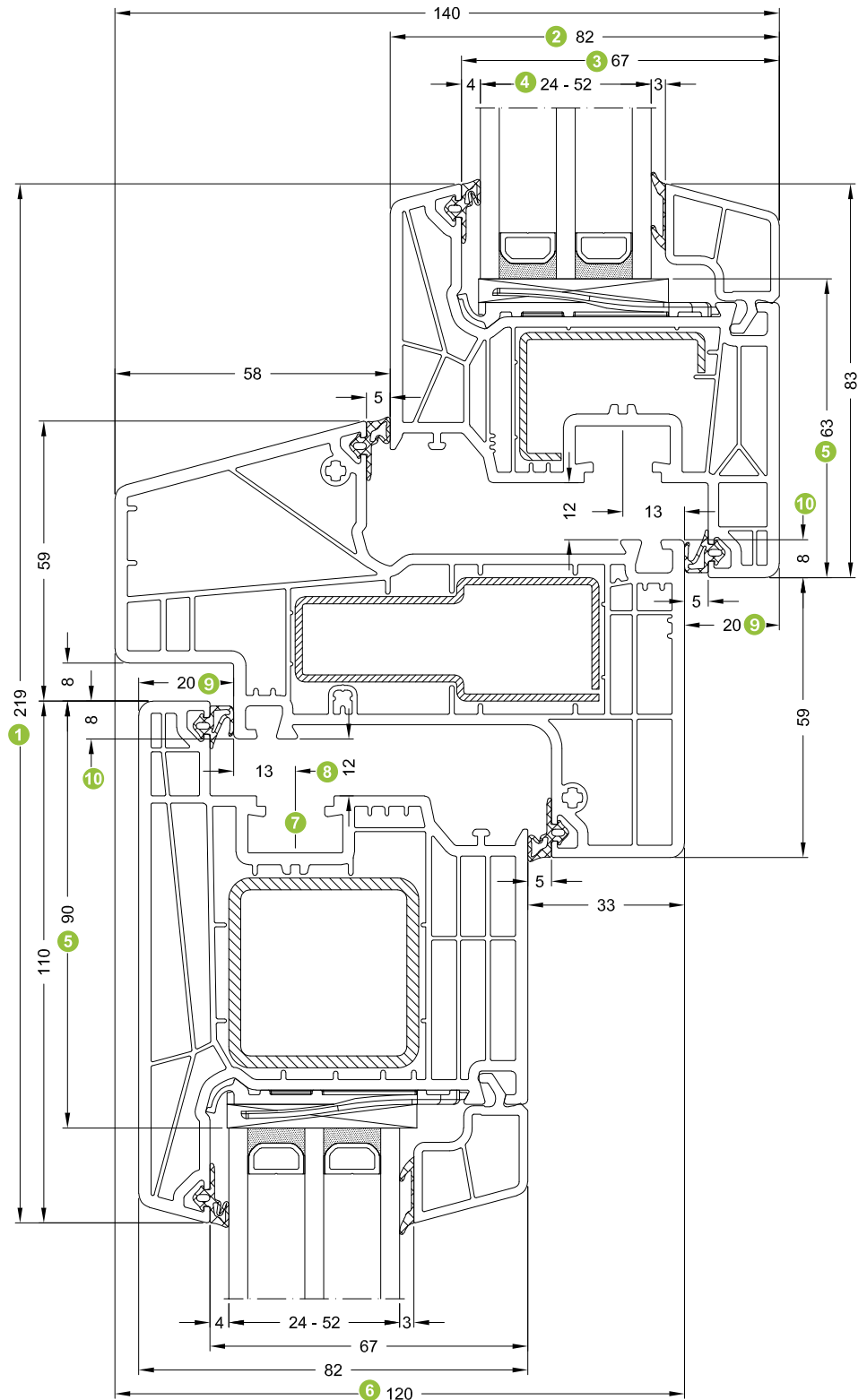

19487...
Wechselprofil 120/92 Variant 15°
Variant reverse rebate profile 120/92, 15°

19452...
Flügelrahmen 82/110 nach außen öffnend
Vent frame 82/110, outward-opening

19431...
Flügelrahmen 82/83
Vent frame 82/83

- | | |
|---|--|
| <ul style="list-style-type: none"> ① Ansichtsbreite
Face width ② Flügelrahmen Bautiefe
Basic depth of vent frame ③ Glasfalzbreite
Glazing rebate width ④ Glasdicke
Glass thickness ⑤ Glasabzugsmaß
Glass deduction | <ul style="list-style-type: none"> ⑥ Wechselprofil Bautiefe
Basic depth of reverse rebate profile ⑦ Achsmaß Beschlag
Axis dimension of fitting ⑧ Falzlufthmaß
Rebate space dimension ⑨ Aufdeckmaß
Tolerance ⑩ Flügelüberschlag
Vent overlap |
|---|--|

Schüco LivIng Variant 15°

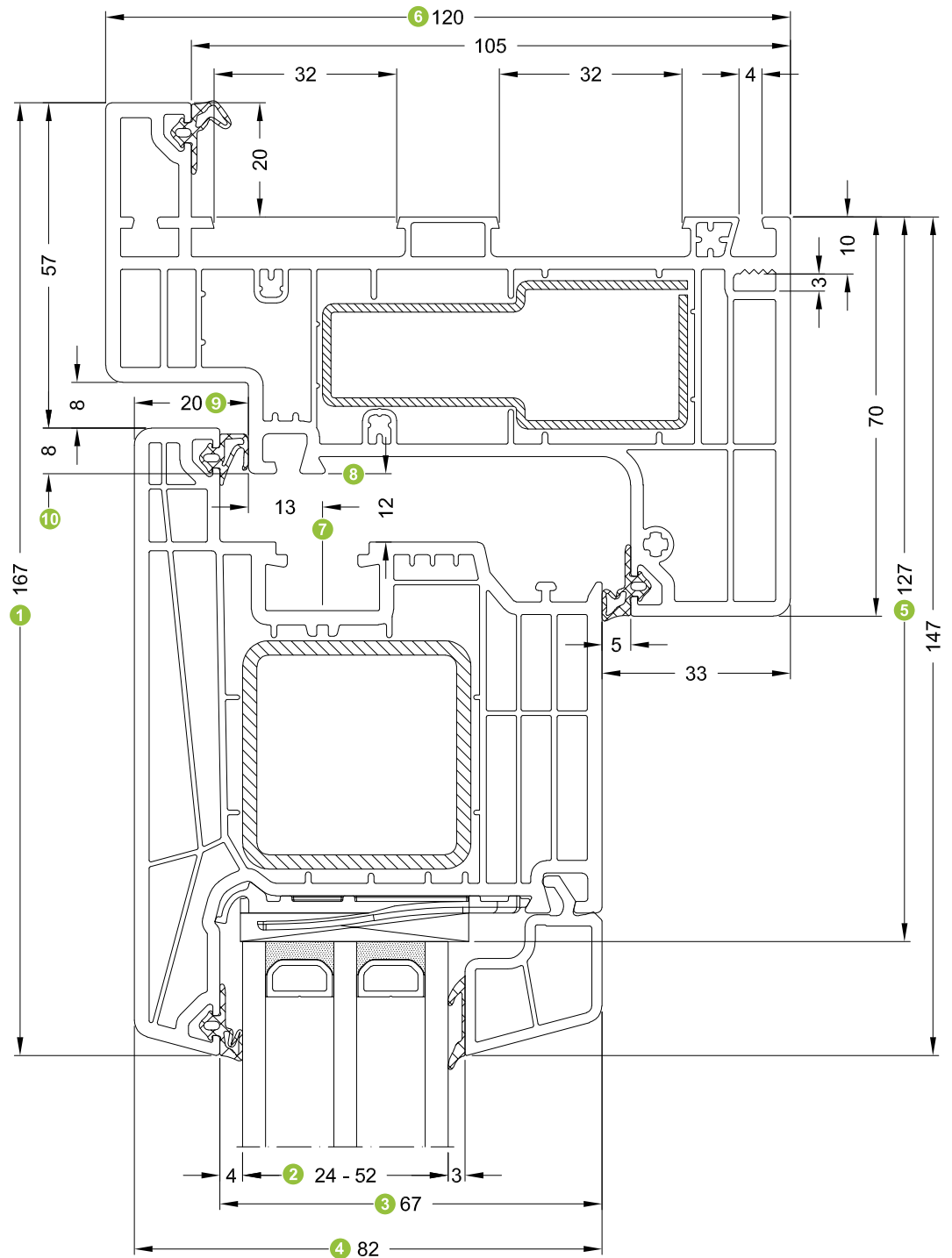

19497...
Blendrahmen 120/70 Variant nach außen öffnend mit Anschlag
Variant outer frame 120/70, 15°, outward-opening with stop

19452...
Flügelrahmen 82/110 nach außen öffnend
Vent frame 82/110, outward-opening

- | | | | |
|---|--|----|--|
| 1 | Ansichtsbreite
Face width | 6 | Blendrahmen Bautiefe
Basic depth of outer frame |
| 2 | Flügelrahmen Bautiefe
Basic depth of vent frame | 7 | Achismaß Beschlag
Axis dimension of fitting |
| 3 | Glasfalzbreite
Glazing rebate width | 8 | Falzlufthmaß
Rebate space dimension |
| 4 | Glasdicke
Glass thickness | 9 | Aufdeckmaß
Tolerance |
| 5 | Glasabzugsmaß
Glass deduction | 10 | Flügelüberschlag
Vent overlap |

Schüco LivIng Variant 15°

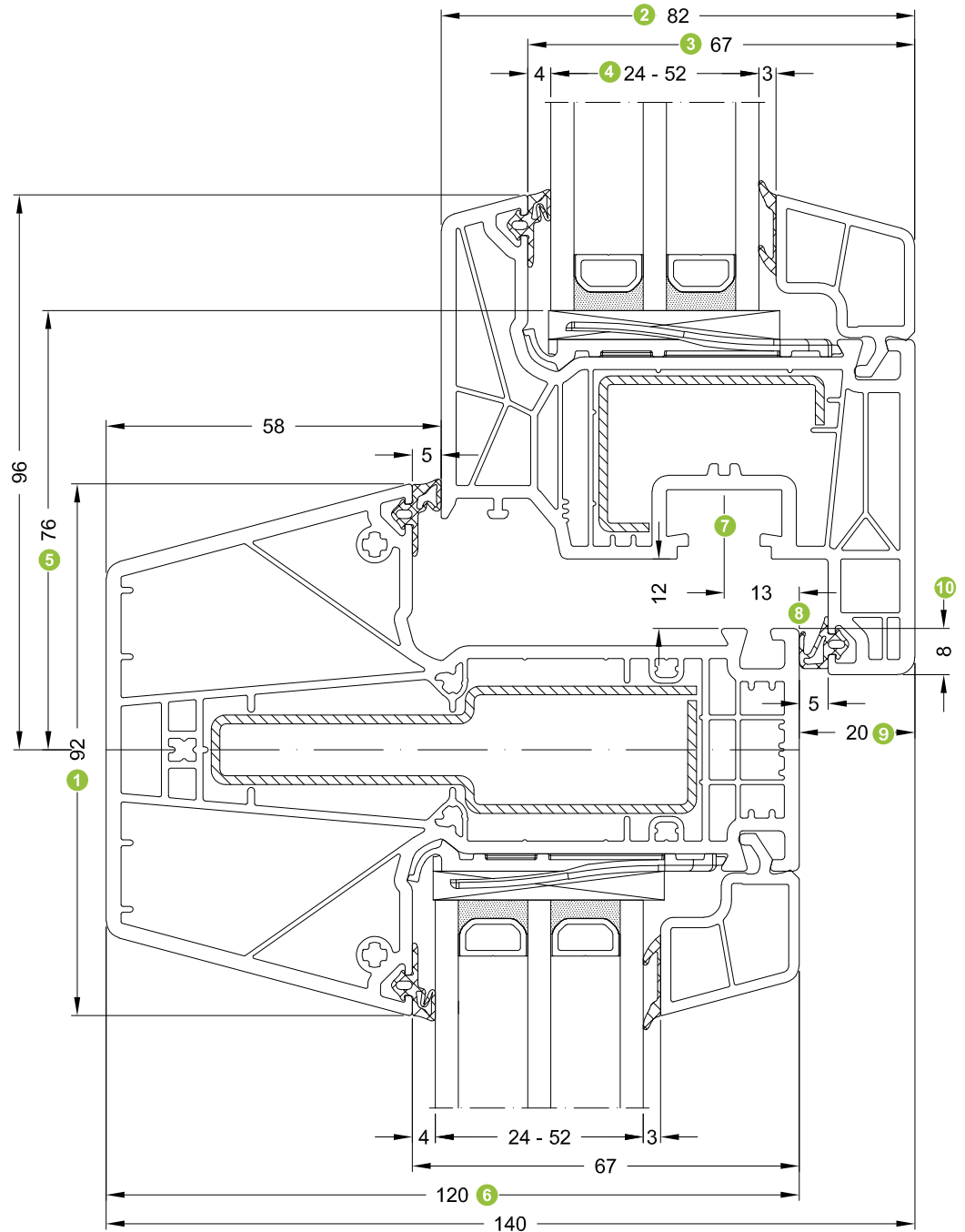

19468...
T-Profil 120/92 Variant 15°
Variant T-profile 120/92, 15°

19431...
Flügelrahmen 82/83
Vent frame 82/83

- | | | | |
|---|--|----|---|
| 1 | T-Profil Ansichtsbreite
Face width of T-profile | 6 | T-Profil Bautiefe
Basic depth of T-profile |
| 2 | Flügelrahmen Bautiefe
Basic depth of vent frame | 7 | Achsmaß Beschlag
Axis dimension of fitting |
| 3 | Glasfalzbreite
Glazing rebate width | 8 | Falzlufmaß
Rebate space dimension |
| 4 | Glasdicke
Glass thickness | 9 | Aufdeckmaß
Tolerance |
| 5 | Glasabzugsmaß
Glass deduction | 10 | Flügelüberschlag
Vent overlap |

Schüco LivIng Variant 6°

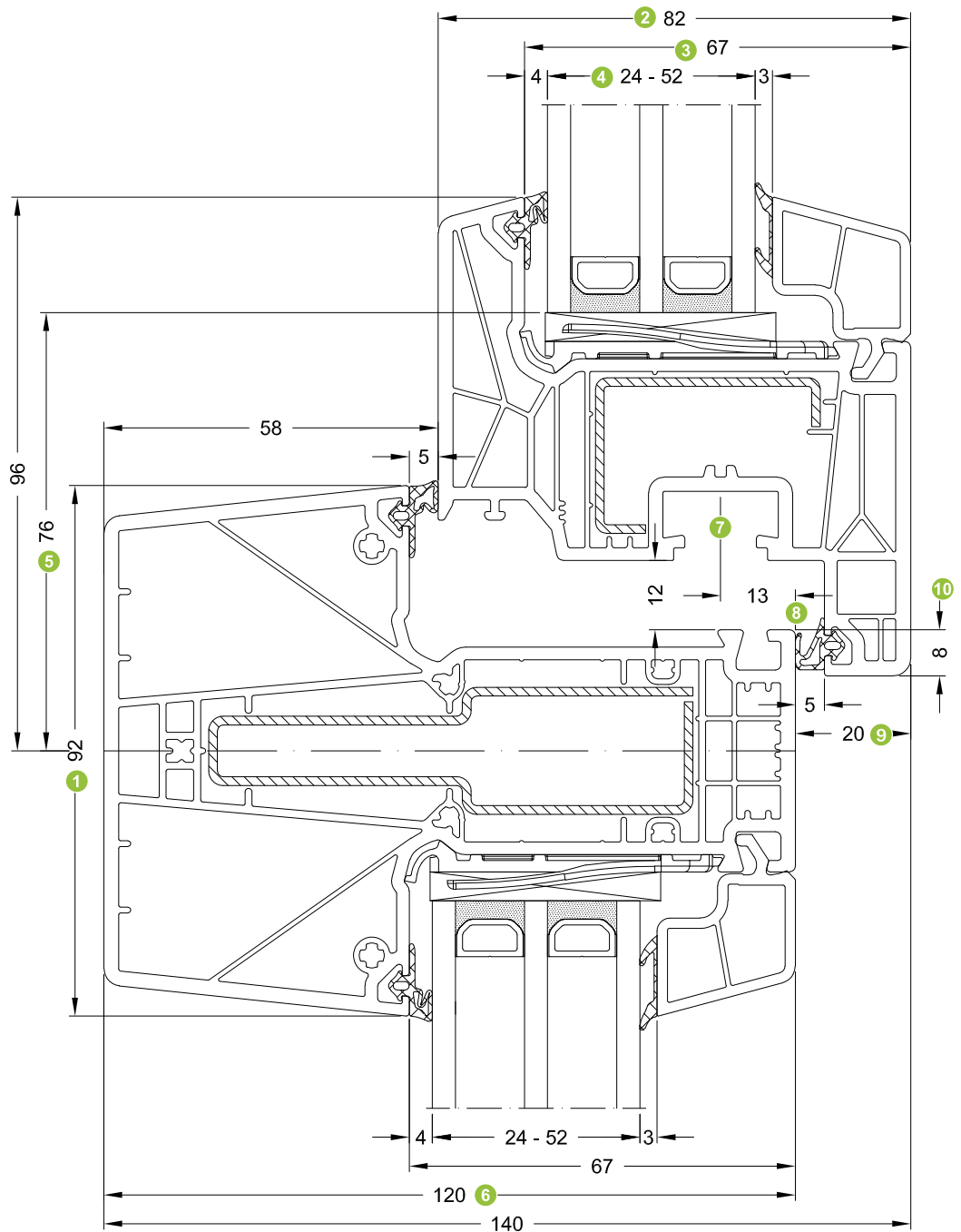

19469...
 T-Profil 120/92 Variant 6°
 Variant T-profile 120/92, 6°

19431...
 Flügelrahmen 82/83
 Vent frame 82/83

- | | |
|---|---|
| 1 T-Profil Ansichtsbreite
Face width of T-profile | 6 T-Profil Bautiefe
Basic depth of T-profile |
| 2 Flügelrahmen Bautiefe
Basic depth of vent frame | 7 Achsmaß Beschlagnagel
Axis dimension of fitting |
| 3 Glasfalzbreite
Glazing rebate width | 8 Falzluftmaß
Rebate space dimension |
| 4 Glasdicke
Glass thickness | 9 Aufdeckmaß
Tolerance |
| 5 Glasabzugsmaß
Glass deduction | 10 Flügelüberschlag
Vent overlap |

Schüco LivIng Variant

Systemeigenschaften
System features

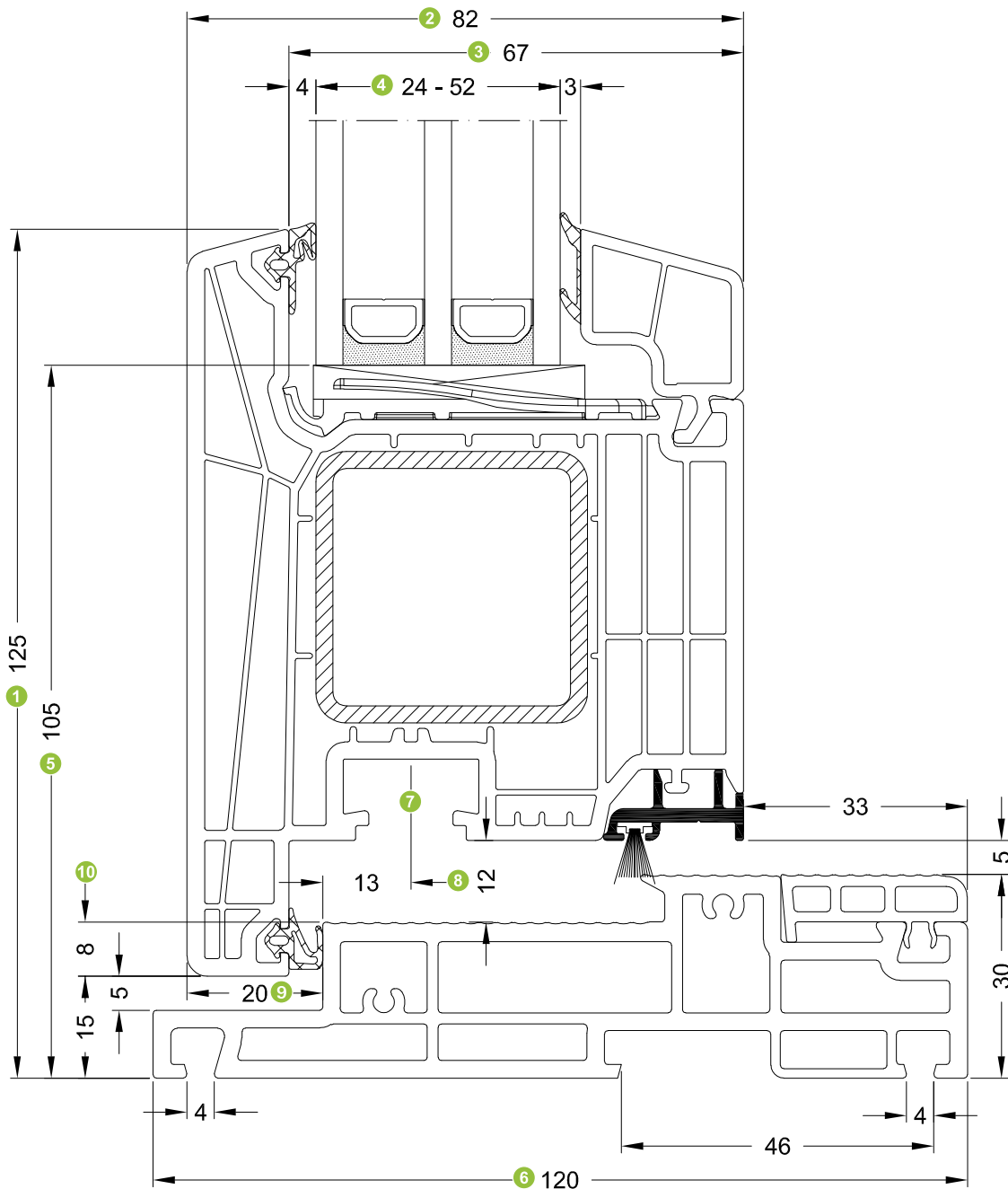

25278200
Türschwelle 120 Variant
Variant door threshold 120

19452...
Flügelrahmen 82/110 nach außen öffnend
Vent frame 82/110, outward-opening

- | | | | |
|---|--|----|---|
| 1 | Ansichtsbreite
Face width | 6 | Türschwelle Bautiefe
Basic depth of door threshold |
| 2 | Flügelrahmen Bautiefe
Basic depth of vent frame | 7 | Achsmaß Beschlag
Axis dimension of fitting |
| 3 | Glasfalzbreite
Glazing rebate width | 8 | Falzlufthmaß
Rebate space dimension |
| 4 | Glasdicke
Glass thickness | 9 | Aufdeckmaß
Tolerance |
| 5 | Glasabzugsmaß
Glass deduction | 10 | Flügelüberschlag
Vent overlap |

Schüco LivIng Variant

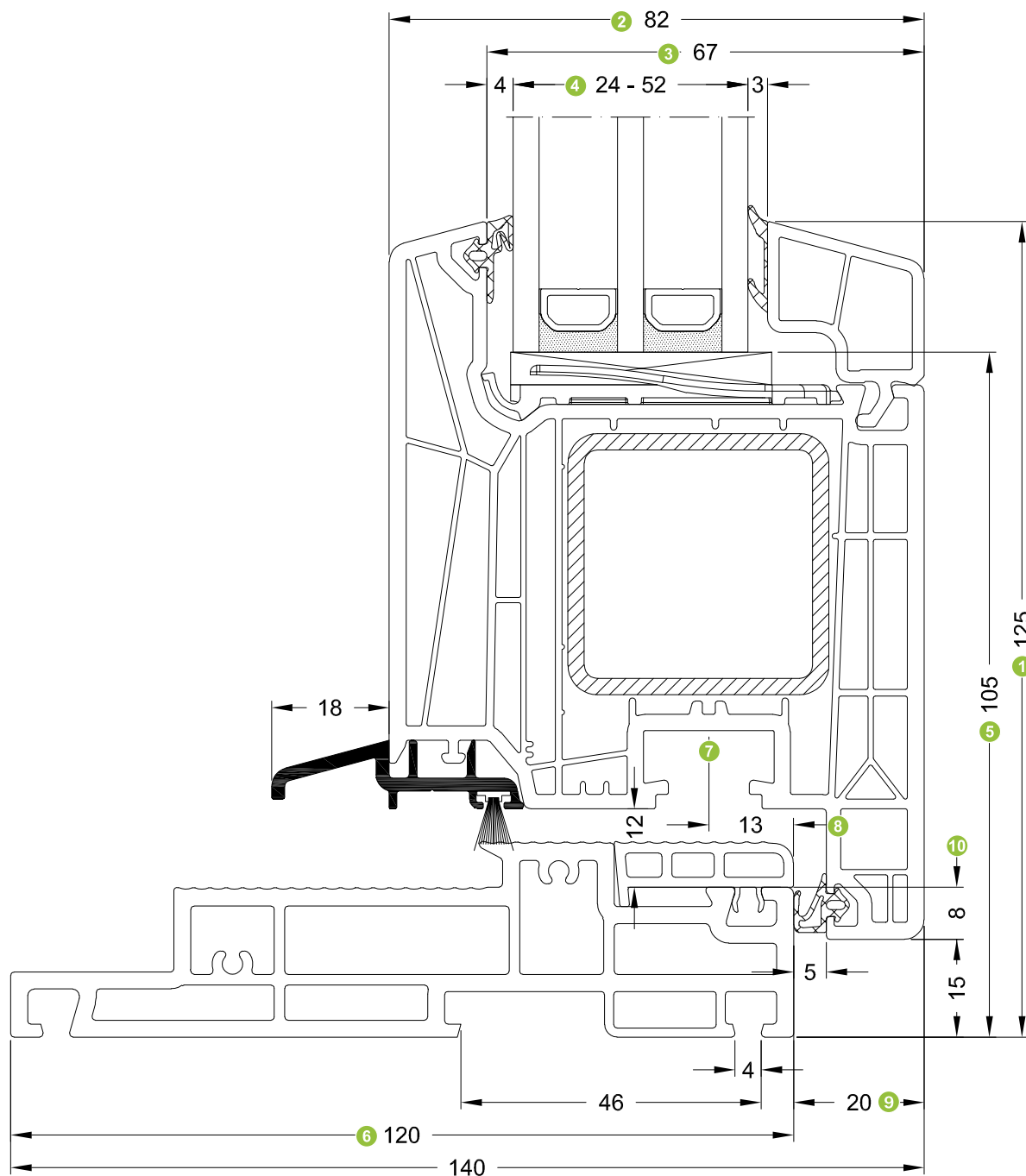

25278200
Türschwelle 120 Variant
Variant door threshold 120

19432...
Flügelrahmen 82/110
Vent frame 82/110

- | | | | |
|---|--|----|---|
| 1 | Ansichtsbreite
Face width | 6 | Türschwelle Bautiefe
Basic depth of door threshold |
| 2 | Flügelrahmen Bautiefe
Basic depth of vent frame | 7 | Achsmaß Beschlag
Axis dimension of fitting |
| 3 | Glasfalzbreite
Glazing rebate width | 8 | Falzlufthmaß
Rebate space dimension |
| 4 | Glasdicke
Glass thickness | 9 | Aufdeckmaß
Tolerance |
| 5 | Glasabzugsmaß
Glass deduction | 10 | Flügelüberschlag
Vent overlap |

Elementtypenübersicht

Overview of unit types

Einteilige Fenster und Fenstertüren ■ Single-part windows and window doors

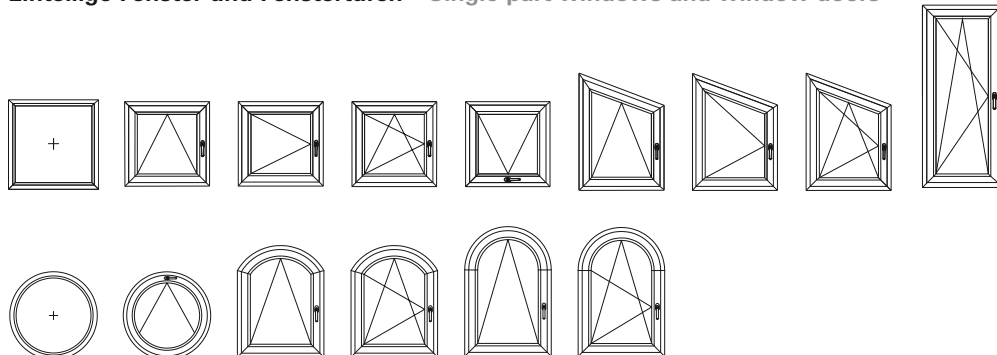

Mehrteilige Fenster und Fenstertüren ■ Multi-part windows and window doors

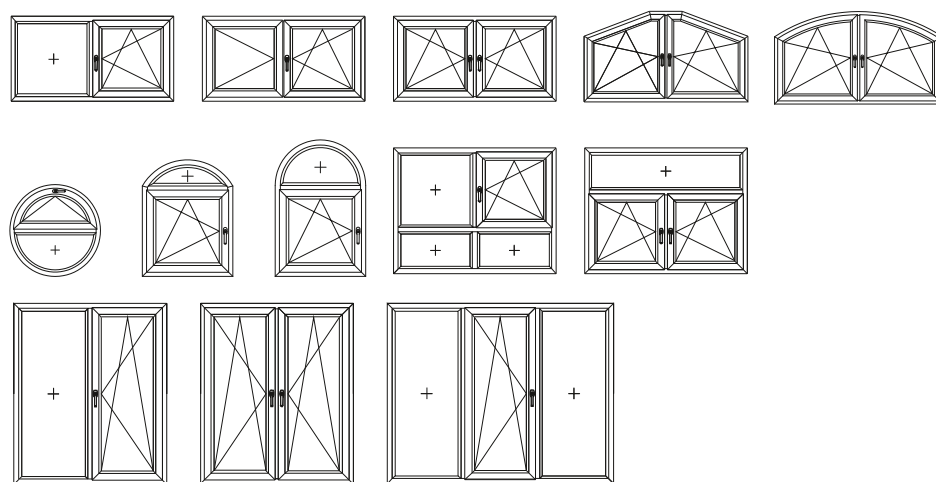

Nebeneingangstüren (NET) und Haustüren (HT)* ■ Side entrance doors (NET) and entrance doors (HT)*

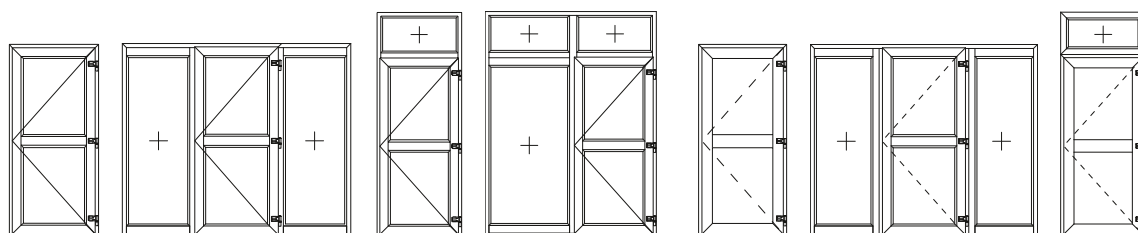

PASK-Fenster und Fenstertüren ■ Tilt/slide windows and window doors

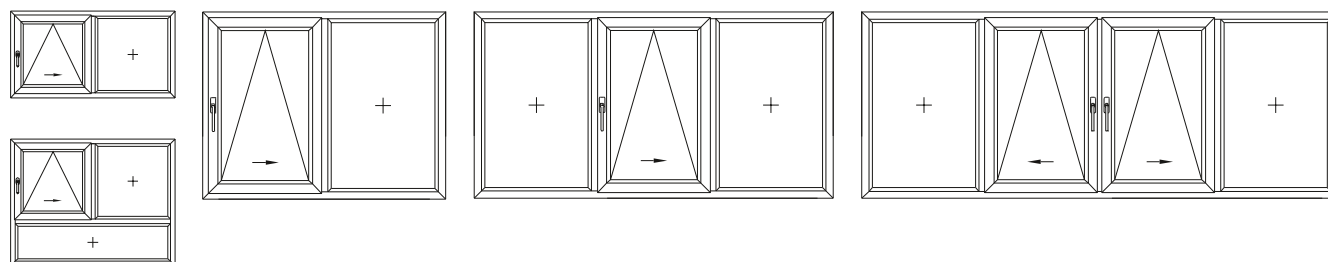

* Nebeneingangstüren und Haustüren können nur mit Schüco LivIng 82 AS /LivIng Variant gebaut werden.





* Side entrance doors and entrance doors can only be constructed using Schüco LivIng 82 AS / LivIng Variant.

Hinweise:

- Die baubaren Größen in Verbindung mit Stahlverstärkungen sind aus den Tabellen „max. Flügelgrößen“ zu entnehmen.
- Bei Festverglasungen darf ein Glasgewicht von 250 kg nicht überschritten werden.

Note:

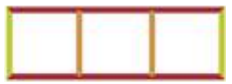
- The sizes that can be constructed in conjunction with steel reinforcements can be found in the “Max. vent sizes” tables.
- For fixed glazing, the glass weight must not exceed 250 kg.

Maximale Flächen und Stablängen je Elementtyp Maximum areas and bar lengths for each unit type					
		1-teilig 1-part	2-teilig 2-part	3- und mehrteilig 3-part and multi-part	PAS / PASK
Maximale Fläche des Elements Maximum area of the unit	weiß White	7,0 m ²			
	foliert Foiled	5,0 m ²			6,0 m ²
Maximale Stablänge Blendrahmen Maximum bar length of outer frame	weiß White	4,0 m			
	foliert Foiled	2,6 m	2,8 m	3,0 m	4,0 m
Maximale Stablänge T-Profil* Maximum bar length of T-profile	weiß White	4,0 m			
	foliert Foiled	2,5 m			
					

* T-Profil als Pfosten oder Riegel einsetzbar
* T-profile can be used as mullion or transom

Schrägelemente

Der kleinstmögliche Spitzenwinkel für Schrägfenster beträgt ca. 60°, hierbei sind jedoch folgende Punkte zu beachten.

Kammermaß = 12 + 1 mm

Aufgrund der geringen Spaltluft im Bereich des Scherenlagers kann es zu Funktionsstörungen beim schließen des Flügels kommen. Daher kann im Bereich der Spitze eine Vergrößerung des Kammermaßes nötig sein (durch beschneiden der Tropfkante).

Bewegliche Flügel müssen immer mit einem Auflaufbock oder Flügelheber ausgestattet sein.

Aufgrund von unterschiedlichen Beschlag-drehachsen und Verarbeitungstoleranzen sind im Grenzbereich vorab Versuche zur Bestimmung der max. Spitzenwinkel unumgänglich.

Es gelten die Allgemeinen Planungs- und Verarbeitungshinweise für Schüco Kunststoff-Systeme.

Shaped units

The smallest possible point angle for shaped windows is approx. 60°. However, the following points must be noted:

Chamber size = 12 + 1 mm

Due to the minimal clearance around the turn/tilt mechanism pivot, the vent may malfunction when closing. It may therefore be necessary to increase the chamber size around the point angle (by cutting the drip edge).

Moving vents must always be fitted with an engagement block or a vent adjuster.

Due to the different rotational axes of the fittings and fabrication tolerances, it is essential that tests be carried out in advance to determine the maximum point angle in the limit range.

The general design and fabrication instructions for Schüco PVC-U systems apply.

Maximale Flügelgrößen Maximum vent sizes

Für die hier aufgeführten Größen gilt:

Die Werte beruhen auf der maximalen Verstärkung des jeweiligen Profils.

Bitte beachten Sie dabei, dass neben der Stahlverstärkung auch die Verarbeitungstechnik (mit oder ohne Klebetechnik) und u. U. auch die Stärke der Glasscheibe einen Einfluss auf die Statik des Flügels hat.

Für weiße Profile ohne Stahlverstärkung gilt:

Die maximale Flügelhöhe wird bei einer Größe von 800 x 1000 mm (b x h) und die maximale Flügelbreite bei einer Größe von 1000 x 800 mm (b x h) erreicht.

Am Pfosten angeschlagene Flügel müssen durch die zusätzliche Gewichtsbelastung bei der Dimensionierung des Pfostens beachtet werden.



Detaillierte Ausführungen zu den einzelnen Profilen und allen möglichen Verstärkungen finden Sie in der Broschüre „Maximale Flügelgrößen“.

The following applies to the sizes listed here:

The values are based on the maximum reinforcement of each profile.

Please note that in addition to the steel reinforcements, the fabrication technology (with or without adhesive technology), and potentially the strength of the glass pane, also have an influence on the statics of the vent.

The following applies to white profiles without steel reinforcement:

The maximum vent height is achieved with dimensions of 800 x 1000 mm (w x h), and the maximum vent width with dimensions of 1000 x 800 mm (w x h).

The additional weight load of vents stacked on the mullion must be taken into account when dimensioning the mullion.

For detailed information about the individual profiles all possible reinforcements, see the “Maximum vent sizes” brochure.

Maximale Flügelhöhen Maximum vent heights

Maximale Flügelgrößen (Flügelbreite x Flügelhöhe in mm) und Glasgewichte Maximum vent sizes (vent width x vent height in mm) and glass weights								
		Windwiderstandsklasse nach EN 12210 ■ Wind resistance class in accordance with EN 12210						
		B5		B3		B2		
Öffnungsart ■ Opening type		weiß White	foliert Foiled	weiß White	foliert Foiled	weiß White	foliert Foiled	
Einflügelige Fenster und Fenstertüren Single-vent windows and window doors	73	700 x 2300	700 x 2200	700 x 2500	700 x 2400	700 x 2500	700 x 2400	60 kg
	83	900 x 2400	1000 x 2300	900 x 2600	1000 x 2500	900 x 2600	1000 x 2500	90 kg
	83*	1000 x 2100	1100 x 2000	900 x 2400	1000 x 2200	900 x 2400	1000 x 2200	90 kg
Stulpfenster und -fenstertüren Double-vent windows and window doors	110	1150 x 2400	1100 x 2300	1150 x 2600	1100 x 2500	1150 x 2600	1100 x 2500	120 kg
	73	400 x 2300	400 x 2200	600 x 2500	600 x 2400	700 x 2550	700 x 2450	60 kg
	83	500 x 2400	500 x 2300	700 x 2600	600 x 2500	1000 x 2600	900 x 2550	90 kg
	83*	400 x 1900	400 x 1805	400 x 2250	400 x 2138	500 x 2390	500 x 2200	90 kg
	110	800 x 2400	800 x 2300	1100 x 2600	1000 x 2500	1100 x 2600	1100 x 2550	120 kg
Einflügelige Nebeneingangstüren Single-leaf side entrance doors	110	—	—	—	—	1000 x 2200	1000 x 2100	80 kg
Zweiflügelige Nebeneingangstüren Double-leaf side entrance doors	110	—	—	—	—	1000 x 2200	1000 x 2100	80 kg
Einflügelige Haustüren Single-leaf entrance doors	125	—	—	—	—	1100 x 2350	1100 x 2200	100 kg
Zweiflügelige Haustüren Double-leaf entrance doors	125	—	—	—	—	1000 x 2350	1000 x 2200	100 kg





Maximale Flügelbreiten Maximum vent widths

Maximale Flügelgrößen (Flügelbreite x Flügelhöhe in mm) und Glasgewichte
Maximum vent sizes (vent width x vent height in mm) and glass weights

		Windwiderstandsklasse nach EN 12210 • Wind resistance class in accordance with EN 12210						
		B5		B3		B2		
Öffnungsart • Opening type		weiß White	foliert Foiled	weiß White	foliert Foiled	weiß White	foliert Foiled	
Einfügelige Fenster und Fenstertüren Single-vent windows and window doors	73	1300 x 1443	1300 x 1343	1300 x 1643	1300 x 1543	1300 x 1643	1300 x 1543	60 kg
	83	1500 x 1660	1500 x 1500	1500 x 1860	1500 x 1700	1500 x 1860	1500 x 1700	90 kg
	83*	1300 x 1800	1300 x 1800	1400 x 1740	1400 x 1640	1400 x 1740	1400 x 1640	90 kg
	110	1500 x 1739	1500 x 1736	1500 x 1939	1500 x 1936	1500 x 1939	1500 x 1936	120 kg
Stulpfenster und -fenstertüren Double-vent windows and window doors	73	1300 x 1443	1300 x 1343	1300 x 1643	1300 x 1543	1300 x 1693	1300 x 1593	60 kg
	83	1350 x 1900	1350 x 1740	1350 x 2100	1350 x 1940	1350 x 2150	1350 x 1990	90 kg
	83*	1300 x 1436	1300 x 1364	1300 x 1650	1300 x 1568	1300 x 1854	1300 x 1761	90 kg
	110	1350 x 2023	1350 x 2007	1350 x 2223	1350 x 2207	1350 x 2273	1350 x 2257	120 kg
Einfügelige Nebeneingangstüren Single-leaf side entrance doors	110	—	—	—	—	1000 x 2200	1000 x 2100	80 kg
Zweifügelige Nebeneingangstüren Double-leaf side entrance doors	110	—	—	—	—	1000 x 2200	1000 x 2100	80 kg
Einfügelige Haustüren Single-leaf entrance doors	125	—	—	—	—	1100 x 2350	1100 x 2200	100 kg
Zweifügelige Haustüren Double-leaf entrance doors	125	—	—	—	—	1000 x 2350	1000 x 2200	100 kg



Eckfestigkeiten von geschweißten Fensterrahmen

Corner stability of welded window frames

Prüfung mittels Wagengerät nach RAL-GZ 716/1, Abschnitt I

Testing using displacement support carriages in accordance with RAL-GZ 716/1, section I

Geltungsbereich: Geschweißte Fensterrahmen aus PVC, die mittels Mehr-Kopf-Schweißmaschinen hergestellt sind.

Scope: welded PVC-U window frames fabricated using multi-head welding machines.

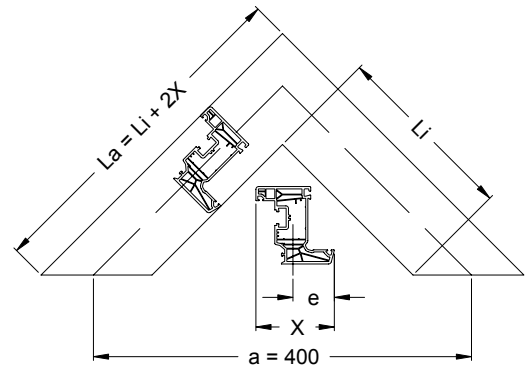
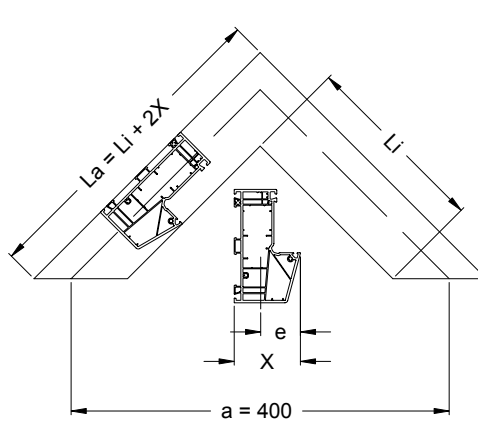

Eckfestigkeit Schüco LivIng Variant
 Corner stability Schüco LivIng Variant

Art.-Nr. Art. No.	Abbildung Illustration	Ansichtsbreite Face width	Schenkellänge Leg length		Bruchkraft Breaking force
		(mm)	innen Inside	außen Outside	F _{SOLL} (kN)
			L _i (mm)	L _a (mm)	
Blendrahmen ■ Outer frame					
19490...		70	200	340	3,24
19491...		90	193	373	4,15
19491...		70	201	341	3,18
19494...		70	200	340	3,25
19495...		90	193	373	4,15

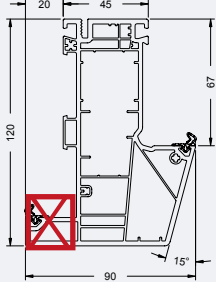
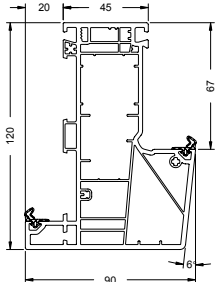
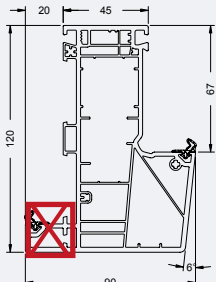
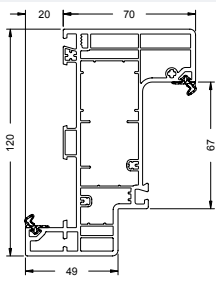
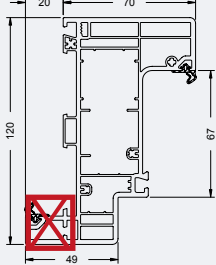
Art.-Nr. Art. No.	Abbildung Illustration	Ansichtsbreite Face width		Schenkellänge Leg length		Bruchkraft Breaking force F _{SOLL} (kN)
		(mm)	innen Inside	außen Outside		
				L _i (mm)	L _a (mm)	
19495...		70	200	340	3,19	
19493...		90	192	372	4,73	
19493...		70	202	342	3,74	
19497...		90	191	371	4,13	
19497...		70	199	339	3,23	

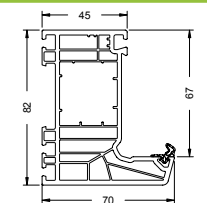
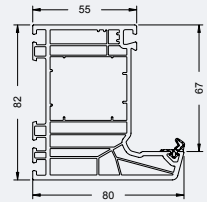
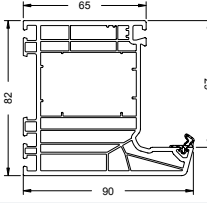
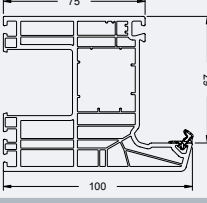
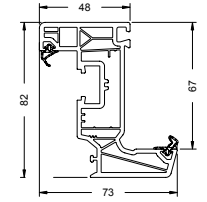
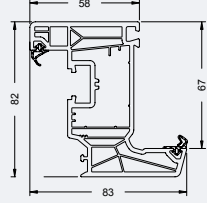
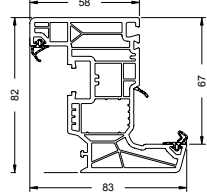
Art.-Nr. Art. No.	Abbildung Illustration	Ansichtsbreite Face width	Schenkellänge Leg length		Bruchkraft Breaking force
		(mm)	innen Inside	außen Outside	F _{SOLL} (kN)
			L _i (mm)	L _a (mm)	
19421...		70	199	339	2,82
19422...		80	189	349	3,96
19423...		90	179	359	5,30
19424...		100	170	370	5,21
Flügelrahmen ■ Vent frame					
19430...		73	206	352	2,27
19431...		83	195	361	3,20
19434...		83	197	363	3,36

Art.-Nr. Art. No.	Abbildung Illustration	Ansichtsbreite Face width	Schenkellänge Leg length		Bruchkraft Breaking force
		(mm)	innen Inside	außen Outside	F _{SOLL} (kN)
			L _i (mm)	L _a (mm)	
19432...		110	197	378	5,55
19433...		125	152	402	8,41
19439...		119,5	155	394	9,66
19452...		110	167	387	5,54
19453...		125	152	402	8,34
19435...		103	186	392	7,05
T-Profile ■ T-profiles					
19468...		92	191	375	4,63

Art.-Nr. Art. No.	Abbildung Illustration	Ansichtsbreite Face width	Schenkellänge Leg length		Bruchkraft Breaking force
		(mm)	innen Inside	außen Outside	F _{SOLL} (kN)
			L _i (mm)	L _a (mm)	
19469...		92	191	375	5,51
19460...		72	211	355	1,96
19461...		92	191	375	3,89
19462...		112	171	395	5,35
Wechselprofile ■ Reverse rebate profiles					
19487...		92	190	374	4,52

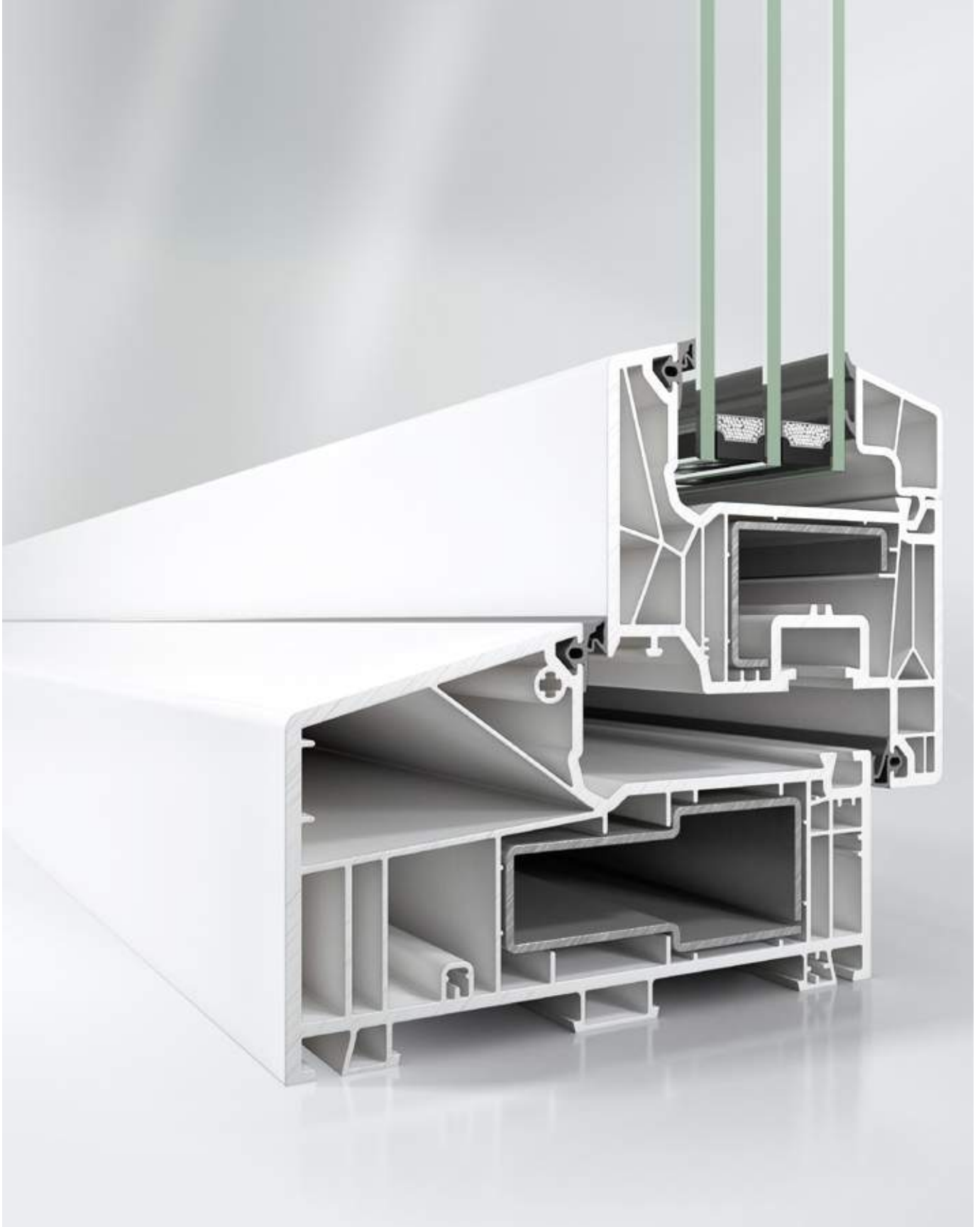



Schüco Liv**Ing** Variant — Profile
Schüco Liv**Ing** Variant — Profiles

- 31 Blendrahmen
Outer frame
- 45 Türschwelle
Door threshold
- 49 Flügelrahmen
Vent frame
- 61 T-Profil und Sprossen
T-profiles and sash bars
- 67 Wechselprofile
Reverse rebate profiles
- 71 Stulpprofile
Meeting stile profiles
- 76 Flachleisten und Winkelprofile für Schüco LivIng Variant (mit Nut)
Flat bar and angled profiles for Schüco LivIng Variant (with groove)

Blendrahmen

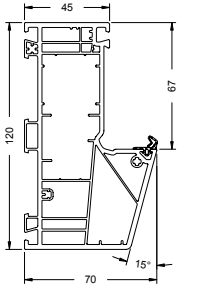
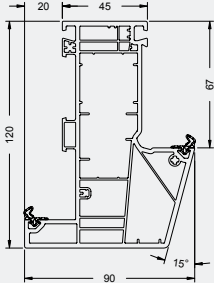
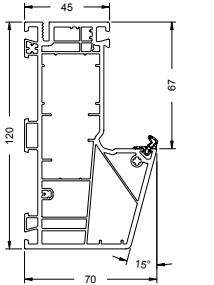
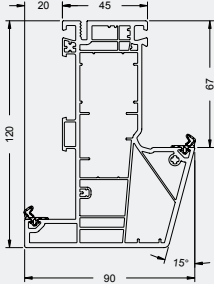
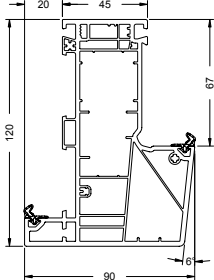
Outer frame



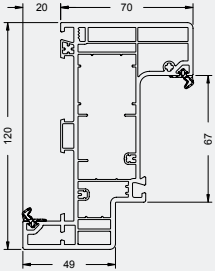
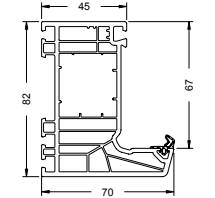
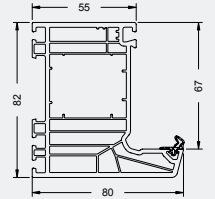
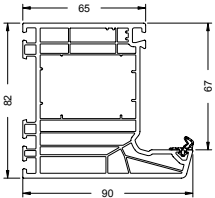
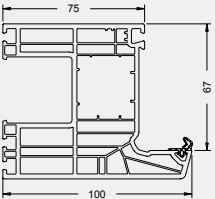
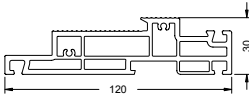

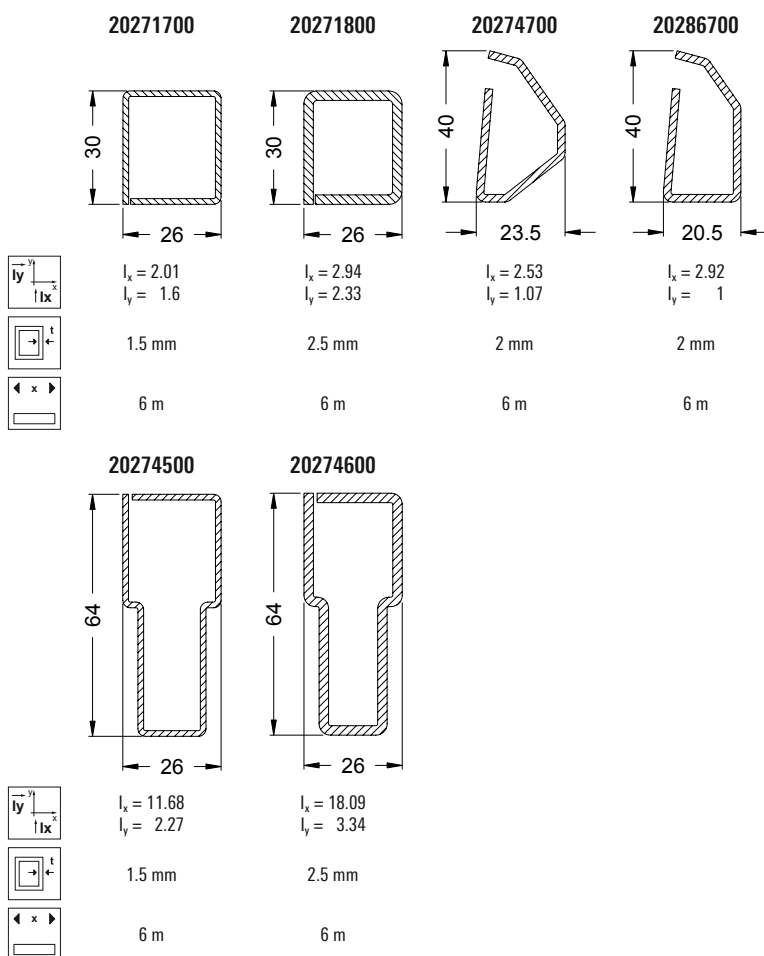
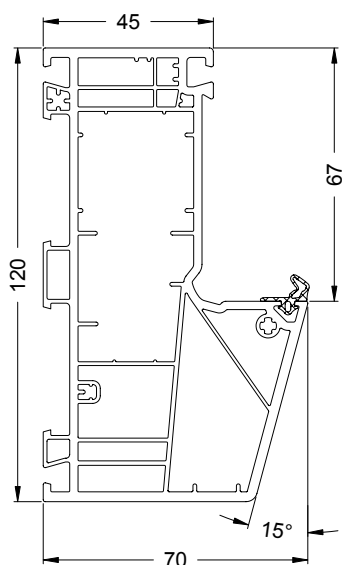

Art.-Nr. Art. No.	Abbildung Illustration	Benennung Description		
19490...		Blendrahmen 120/70 Variant 15° Variant outer frame 120/70, 15°	AS	33
19491...		Blendrahmen 120/90 Variant 15° mit Anschlag Variant outer frame 120/90, 15°, with stop	AS	35
19494...		Blendrahmen 120/70 Variant 15° mit Nut Variant outer frame 120/70, 15°, with groove	AS	36
19495...		Blendrahmen 120/90 Variant 15° mit Anschlag und Nut Variant outer frame 120/90, 15°, with stop and groove	AS	38
19493...		Blendrahmen 120/90 Variant 6° mit Anschlag Variant outer frame 120/90, 6°, with stop	AS	39

Art.-Nr. Art. No.	Abbildung Illustration	Benennung Description		
19497...		Blendrahmen 120/70 Variant nach außen öffnend mit Anschlag Variant outer frame 120/70, 15°, outward-opening with stop	AS	40
19421...		Blendrahmen 82/70 AS Outer frame 82/70 AS	AS	41
19422...		Blendrahmen 82/80 AS Outer frame 82/80 AS	AS	42
19423...		Blendrahmen 82/90 AS Outer frame 82/90 AS	AS	43
19424...		Blendrahmen 82/100 AS Outer frame 82/100 AS	AS	44
25278200		Türschwelle 120 Variant Variant door threshold 120	AS	45

Blendrahmen 120/70 Variant 15° ■ Variant outer frame 120/70, 15°
19490...



Art.-Nr. Art. No.	Abbildung Illustration	Benennung Description			
25254600		Reparaturdichtung: Anschlag- und Glasanlagedichtung Repair gasket: rebate gasket and glazing rebate gasket	schwarz Black	100 m*	EPDM-Dichtung, polymerisiert, nicht schweißbar EPDM gasket, polymerised, cannot be welded
25254500		Reparaturdichtung: Anschlag- und Glasanlagedichtung Repair gasket: rebate gasket and glazing rebate gasket	silbergrau Silver grey		
25282000		Reparaturdichtung: Anschlag- und Glasanlagedichtung Repair gasket: rebate gasket and glazing rebate gasket	schwarz Black	100 m*	EPDM-Dichtung, nicht polymerisiert, schweißbar EPDM gasket, not polymerised, weldable
25281900		Reparaturdichtung: Anschlag- und Glasanlagedichtung Repair gasket: rebate gasket and glazing rebate gasket	silbergrau Silver grey		
25094900		Klotzbrücke Glazing bridge	braun Brown	250 Stk.	Tragklotz für 3 mm Falztiefe Support block for 3 mm rebate depth
25094800		Klotzbrücke Glazing bridge	violett Violet	250 Stk.	Distanzklotz für 3 mm Falztiefe Spacer block for 3 mm rebate depth
24205900		Entwässerungskappe Drainage cover cap	weiß White	1000 Stk.	—
25089000		Eindrehanke Fixing lug	verzinkt Galvanised	100 Stk.	150 mm lang 150 mm long
25089500					200 mm lang 200 mm long
25286100					250 mm lang 250 mm long
25286200					300 mm lang 300 mm long
					50 Stk.

Art.-Nr. Art. No.	Abbildung Illustration	Benennung Description			
25261300		Fensterfalzlüfter Schüco VentoAir RF LivIng 82 AS Schüco VentoAir RF LivIng 82 AS window rebate fan	weiß White	20 Stk.	Set aus Trägerbauteil, Flügelsystemdichtung grau, Rückstellfeder Kit comprises bracket components, grey vent system gasket, release spring
28687200		Nutabdeckprofil Groove cover profile	weiß White	300 m	Abdeckung der Glasleistennut Covering the glazing bead groove
28687300			cremeweiß Cream white		
Zusatzprofile Supplementary profiles					
19051...		Anschlussprofil 12,5/20 mit Dichtung Attachment profile 12.5/20 with gasket	foliert Foiled	6 m	—
19051150			schwarz Black		

Anschlussmöglichkeiten 19490

Attachment options 19490

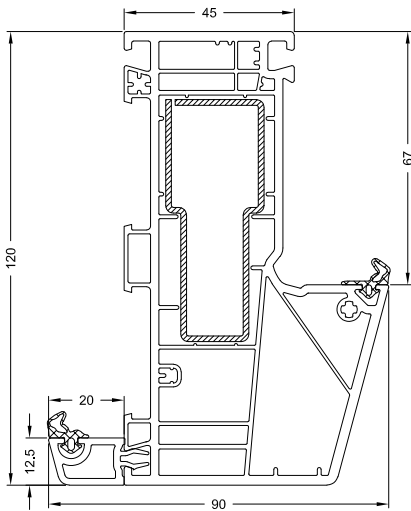

Blendrahmen 120/90 Variant 15° mit Anschlag ■ Variant outer frame 120/90, 15°, with stop
19491...

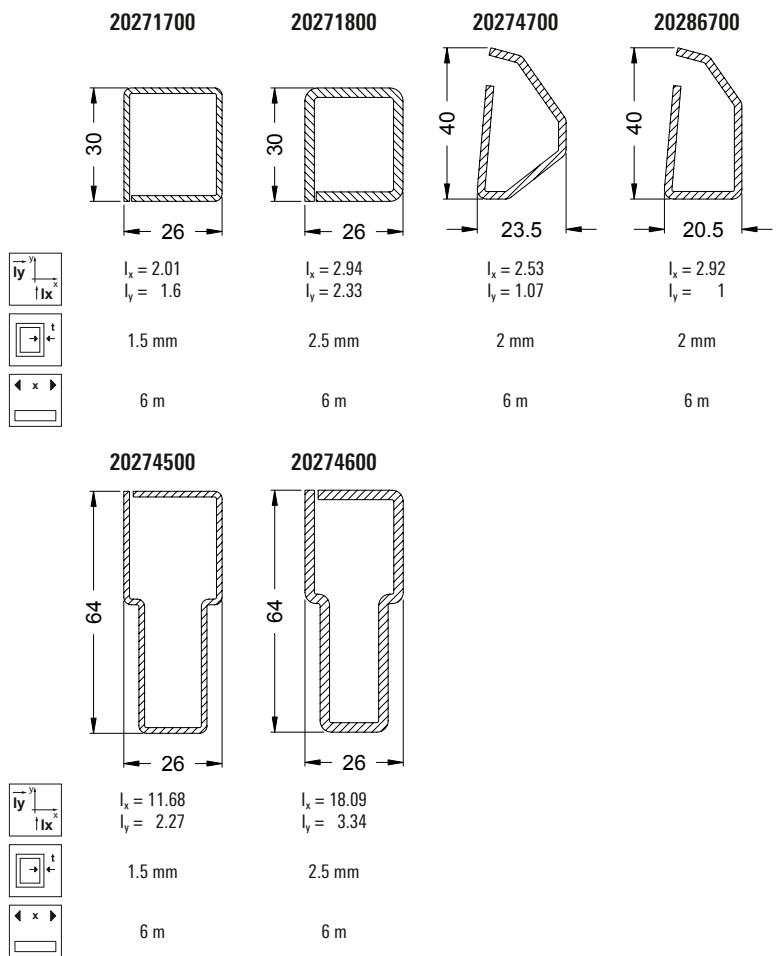
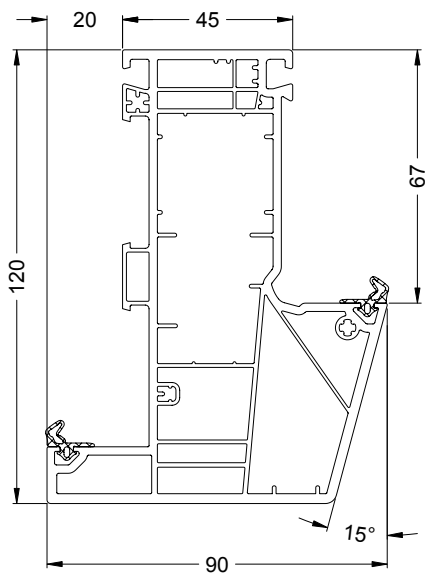

Art.-Nr. Art. No.	Abbildung Illustration	Benennung Description			
25254600		Reparaturdichtung: Anschlag- und Glasanlagendichtung	schwarz Black	100 m*	EPDM-Dichtung, polymerisiert, nicht schweißbar EPDM gasket, polymerised, cannot be welded
25254500		Repair gasket: rebate gasket and glazing rebate gasket	silbergrau Silver grey		
25282000		Reparaturdichtung: Anschlag- und Glasanlagendichtung	schwarz Black	100 m*	EPDM-Dichtung, nicht polymerisiert, schweißbar EPDM gasket, not polymerised, weldable
25281900		Repair gasket: rebate gasket and glazing rebate gasket	silbergrau Silver grey		
25094900		Klotzbrücke Glazing bridge	braun Brown	250 Stk.	Tragklotz für 3 mm Falztiefe Support block for 3 mm rebate depth
25094800		Klotzbrücke Glazing bridge	violett Violet	250 Stk.	Distanzklotz für 3 mm Falztiefe Spacer block for 3 mm rebate depth
24205900		Entwässerungskappe Drainage cover cap	weiß White	1000 Stk.	—
25089000		Eindrehhanker Fixing lug	verzinkt Galvanised	100 Stk.	150 mm lang 150 mm long
25089500					200 mm lang 200 mm long
25286100					200 mm lang 250 mm long
25286200					250 mm lang
					300 mm lang 300 mm long
25261300		Fensterfalzlüfter Schüco VentoAir RF LivIng 82 AS Schüco VentoAir RF LivIng 82 AS window rebate fan	weiß White	20 Stk.	Set aus Trägerbauteil, Flügelsystemdichtung grau, Rückstellfeder Kit comprises bracket components, grey vent system gasket, release spring
28687200		Nutabdeckprofil Groove cover profile	weiß White	300 m	Abdeckung der Glasleistennut Covering the glazing bead groove
28687300			cremeweiß Cream white		



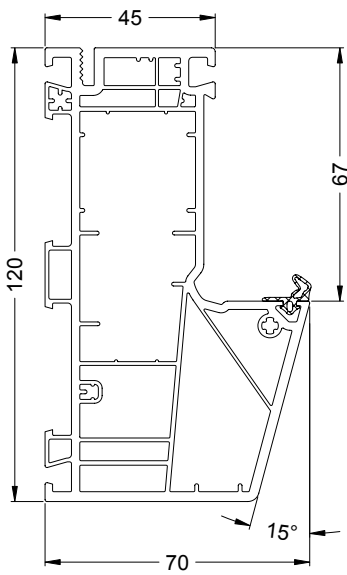

Blendrahmen 120/70 Variant 15° mit Nut ■ Variant outer frame 120/70, 15°, with groove
19494...



Passende Nutprofile siehe „Flachleisten und Winkelprofile“
See “Flat bar and angled profiles” for the appropriate groove profiles

	20271700	20271800	20274700	20286700
$I_x = 2.01$ $I_y = 1.6$	$I_x = 2.94$ $I_y = 2.33$	$I_x = 2.53$ $I_y = 1.07$	$I_x = 2.92$ $I_y = 1$	
1.5 mm	2.5 mm	2 mm	2 mm	
6 m	6 m	6 m	6 m	
	20274500	20274600		
$I_x = 11.68$ $I_y = 2.27$	$I_x = 18.09$ $I_y = 3.34$			
1.5 mm	2.5 mm			
6 m	6 m			

Art.-Nr. Art. No.	Abbildung Illustration	Benennung Description			
25254600		Reparaturdichtung: Anschlag- und Glasanlagendichtung Repair gasket: rebate gasket and glazing rebate gasket	schwarz Black	100 m*	EPDM-Dichtung, polymerisiert, nicht schweißbar EPDM gasket, polymerised, cannot be welded
25254500			silbergrau Silver grey		
25282000		Reparaturdichtung: Anschlag- und Glasanlagendichtung Repair gasket: rebate gasket and glazing rebate gasket	schwarz Black	100 m*	EPDM-Dichtung, nicht polymerisiert, schweißbar EPDM gasket, not polymerised, weldable
25281900			silbergrau Silver grey		
25094900		Klotzbrücke Glazing bridge	braun Brown	250 Stk.	Tragklotz für 3 mm Falztiefe Support block for 3 mm rebate depth
25094800		Klotzbrücke Glazing bridge	violett Violet	250 Stk.	Distanzklotz für 3 mm Falztiefe Spacer block for 3 mm rebate depth
24205900		Entwässerungskappe Drainage cover cap	weiß White	1000 Stk.	—
25089000		Eindrehanker Fixing lug	verzinkt Galvanised	100 Stk.	150 mm lang 150 mm long
25089500					200 mm lang 200 mm long
25286100					250 mm lang 250 mm long
25286200					300 mm lang 300 mm long
25261300		Fensterfalzlüfter Schüco VentoAir RF LivIng 82 AS Schüco VentoAir RF LivIng 82 AS window rebate fan	weiß White	20 Stk.	Set aus Trägerbauteil, Flügelsystemdichtung grau, Rückstellfeder Kit comprises bracket components, grey vent system gasket, release spring

Art.-Nr. Art. No.	Abbildung Illustration	Benennung Description			
28687200		Nutabdeckprofil Groove cover profile	weiß White	300 m	Abdeckung der Glasleistennut Covering the glazing bead groove
28687300			cremeweiß Cream white		
Zusatzprofile Supplementary profiles					
19051...		Anschlussprofil 12,5/20 mit Dichtung Attachment profile 12.5/20 with gasket	foliert Foiled	6 m	—
19051150			schwarz Black		

Anschlussmöglichkeiten 19494
 Attachment options 19494

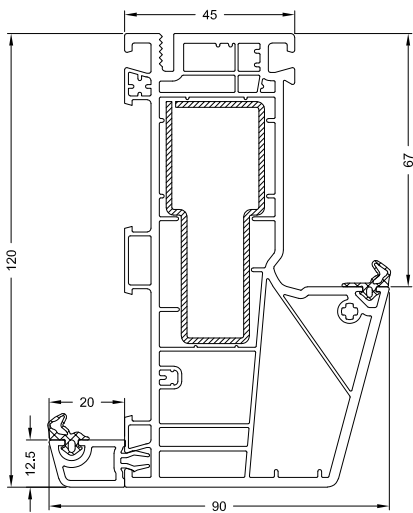



Blendrahmen 120/90 Variant 15° mit Anschlag und Nut
Variant outer frame 120/90, 15°, with stop and groove

19495...

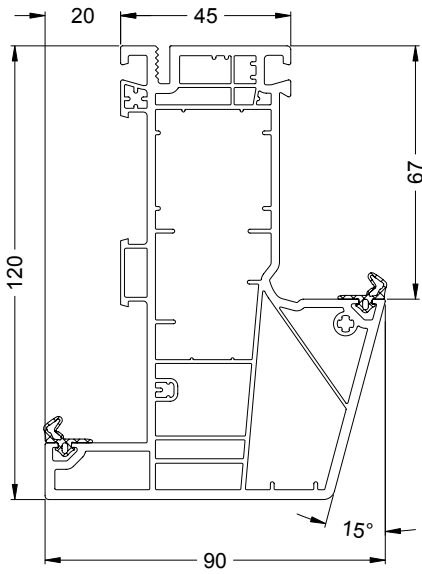

Passende Nutprofile siehe „Flachleisten und Winkelprofile“
See "Flat bar and angled profiles" for the appropriate groove profiles

	20271700	20271800	20274700	20286700
$I_x = 2.01$ $I_y = 1.6$	$I_x = 2.94$ $I_y = 2.33$	$I_x = 2.53$ $I_y = 1.07$	$I_x = 2.92$ $I_y = 1$	
1.5 mm	2.5 mm	2 mm	2 mm	
6 m	6 m	6 m	6 m	
	20274500	20274600		
$I_x = 11.68$ $I_y = 2.27$	$I_x = 18.09$ $I_y = 3.34$			
1.5 mm	2.5 mm			
6 m	6 m			

Art.-Nr. Art. No.	Abbildung Illustration	Benennung Description			
25254600		Reparaturdichtung: Anschlag- und Glasanlagendichtung Repair gasket: rebate gasket and glazing rebate gasket	schwarz Black	100 m*	EPDM-Dichtung, polymerisiert, nicht schweißbar EPDM gasket, polymerised, cannot be welded
25254500		Reparaturdichtung: Anschlag- und Glasanlagendichtung Repair gasket: rebate gasket and glazing rebate gasket	silbergrau Silver grey		
25282000		Reparaturdichtung: Anschlag- und Glasanlagendichtung Repair gasket: rebate gasket and glazing rebate gasket	schwarz Black	100 m*	EPDM-Dichtung, nicht polymerisiert, schweißbar EPDM gasket, not polymerised, weldable
25281900		Reparaturdichtung: Anschlag- und Glasanlagendichtung Repair gasket: rebate gasket and glazing rebate gasket	silbergrau Silver grey		
25094900		Klotzbrücke Glazing bridge	braun Brown	250 Stk.	Tragklotz für 3 mm Falztiefe Support block for 3 mm rebate depth
25094800		Klotzbrücke Glazing bridge	violett Violet	250 Stk.	Distanzklotz für 3 mm Falztiefe Spacer block for 3 mm rebate depth
24205900		Entwässerungskappe Drainage cover cap	weiß White	1000 Stk.	—
25089000		Eindrehhanker Fixing lug	verzinkt Galvanised	100 Stk.	150 mm lang 150 mm long
25089500					200 mm lang 200 mm long
25286100					250 mm lang 250 mm long
25286200					300 mm lang 300 mm long
					50 Stk.
25261300		Fensterfalzlüfter Schüco VentoAir RF LivIng 82 AS Schüco VentoAir RF Living 82 AS window rebate fan	weiß White	20 Stk.	Set aus Trägerbauteil, Flügelsystemdichtung grau, Rückstellfeder Kit comprises bracket components, grey vent system gasket, release spring
28687200		Nutabdeckprofil Groove cover profile	weiß White cremeweiß Cream white	300 m	Abdeckung der Glasleistennut Covering the glazing bead groove
28687300					



Blendrahmen 120/90 Variant 6° mit Anschlag
Variant outer frame 120/90, 6°, with stop

19493...

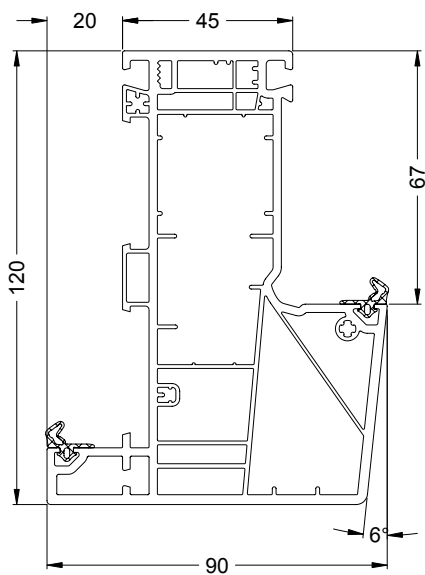

Passende Nutprofile siehe „Flachleisten und Winkelprofile“
See "Flat bar and angled profiles" for the appropriate groove profiles

20271700

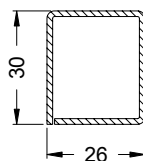

$$I_x = 2.01$$

$$I_y = 1.6$$

1.5 mm

6 m

20271800

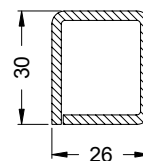

$$I_x = 2.94$$

$$I_y = 2.33$$

2.5 mm

6 m

20286800

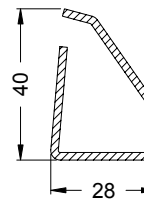

$$I_x = 3.27$$

$$I_y = 1.85$$

2 mm

6 m

20274500

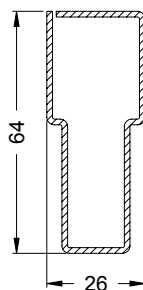

$$I_x = 11.68$$

$$I_y = 2.27$$

1.5 mm

6 m

20274600

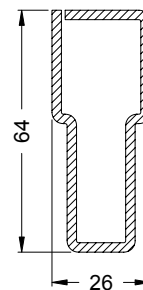

$$I_x = 18.09$$

$$I_y = 3.34$$

2.5 mm

6 m

Art.-Nr. Art. No.	Abbildung Illustration	Benennung Description			
25254600		Reparaturdichtung: Anschlag- und Glasanlagendichtung Repair gasket: rebate gasket and glazing rebate gasket	schwarz Black	100 m*	EPDM-Dichtung, polymerisiert, nicht schweißbar EPDM gasket, polymerised, cannot be welded
25254500		Reparaturdichtung: Anschlag- und Glasanlagendichtung Repair gasket: rebate gasket and glazing rebate gasket	silbergrau Silver grey		
25282000		Reparaturdichtung: Anschlag- und Glasanlagendichtung Repair gasket: rebate gasket and glazing rebate gasket	schwarz Black	100 m*	EPDM-Dichtung, nicht polymerisiert, schweißbar EPDM gasket, not polymerised, weldable
25281900		Reparaturdichtung: Anschlag- und Glasanlagendichtung Repair gasket: rebate gasket and glazing rebate gasket	silbergrau Silver grey		
25094900		Klotzbrücke Glazing bridge	braun Brown	250 Stk.	Tragklotz für 3 mm Falztiefe Support block for 3 mm rebate depth
25094800		Klotzbrücke Glazing bridge	violett Violet	250 Stk.	Distanzklotz für 3 mm Falztiefe Spacer block for 3 mm rebate depth
24205900		Entwässerungskappe Drainage cover cap	weiß White	1000 Stk.	—
25089000		Eindrehanker Fixing lug	verzinkt Galvanised	100 Stk.	150 mm lang 150 mm long
25089500					200 mm lang 200 mm long
25286100					250 mm lang 250 mm long
25286200					300 mm lang 300 mm long
25261300		Fensterfalzlüfter Schüco VentoAir RF LivIng 82 AS Schüco VentoAir RF LivIng 82 AS window rebate fan	weiß White	20 Stk.	Set aus Trägerbauteil, Flügelsystemdichtung grau, Rückstellfeder Kit comprises bracket components, grey vent system gasket, release spring
28687200		Nutabdeckprofil Groove cover profile	weiß White	300 m	Abdeckung der Glasleistennut Covering the glazing bead groove
28687300					

Blendrahmen 120/70 Variant nach außen öffnend mit Anschlag
Variant outer frame 120/70, 15°, outward-opening with stop



19497...

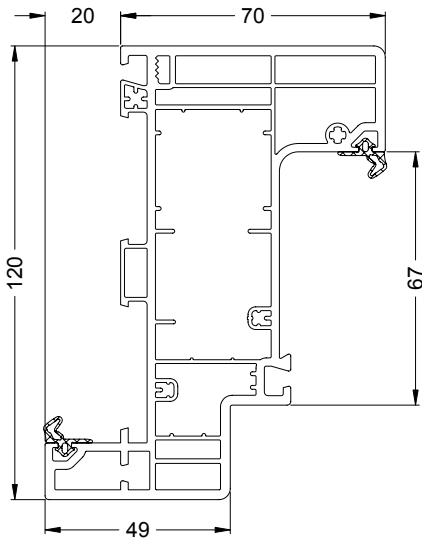

20274800

20271700

20271800

20274500

20274600

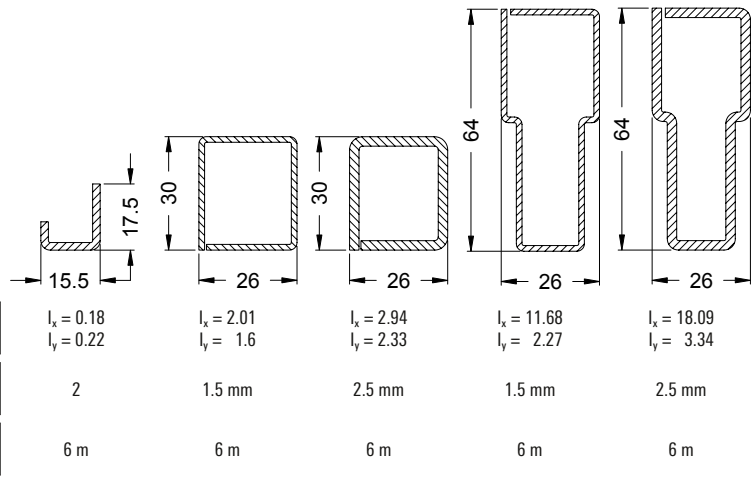

Passende Nutprofile siehe „Flachleisten und Winkelprofile“
See "Flat bar and angled profiles" for the appropriate groove profiles

Art.-Nr. Art. No.	Abbildung Illustration	Benennung Description			
25254600		Reparaturdichtung: Anschlag- und Glasanlagedichtung Repair gasket: rebate gasket and glazing rebate gasket	schwarz Black	100 m*	EPDM-Dichtung, polymerisiert, nicht schweißbar EPDM gasket, polymerised, cannot be welded
25254500		Reparaturdichtung: Anschlag- und Glasanlagedichtung Repair gasket: rebate gasket and glazing rebate gasket	silbergrau Silver grey		
25282000		Reparaturdichtung: Anschlag- und Glasanlagedichtung Repair gasket: rebate gasket and glazing rebate gasket	schwarz Black	100 m*	EPDM-Dichtung, nicht polymerisiert, schweißbar EPDM gasket, not polymerised, weldable
25281900		Reparaturdichtung: Anschlag- und Glasanlagedichtung Repair gasket: rebate gasket and glazing rebate gasket	silbergrau Silver grey		
25089000		Eindrehanker Fixing lug	verzinkt Galvanised	100 Stk.	150 mm lang 150 mm long
25089500					200 mm lang 200 mm long
25286100					250 mm lang 250 mm long
25286200					300 mm lang 300 mm long
28687200		Nutabdeckprofil Groove cover profile	weiß White	300 m	Abdeckung der Glasleistennut Covering the glazing bead groove
28687300			cremeweiß Cream white		

Blendrahmen 82/70 AS ■ Outer frame 82/70 AS
19421...

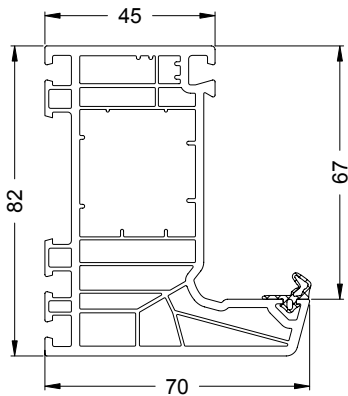

	20271500	20271700	20271800	20281200
$I_x = 1.35$ $I_y = 0.72$	$I_x = 2.01$ $I_y = 1.6$	$I_x = 2.94$ $I_y = 2.33$	$I_x = 1.17$ $I_y = 2$	
1.5 mm	1.5 mm	2.5 mm	2.5 mm	
6 m	6 m	6 m	6 m	

Art.-Nr. Art. No.	Abbildung Illustration	Benennung Description			
25254600		Reparaturdichtung: Anschlag- und Glasanlagedichtung Repair gasket: rebate gasket and glazing rebate gasket	schwarz Black	100 m*	EPDM-Dichtung, polymerisiert, nicht schweißbar EPDM gasket, polymerised, cannot be welded
25254500			silbergrau Silver grey		
25282000		Reparaturdichtung: Anschlag- und Glasanlagedichtung Repair gasket: rebate gasket and glazing rebate gasket	schwarz Black	100 m*	EPDM-Dichtung, nicht polymerisiert, schweißbar EPDM gasket, not polymerised, weldable
25281900			silbergrau Silver grey		
25094900		Klotzbrücke Glazing bridge	braun Brown	250 Stk.	Tragklotz für 3 mm Falztiefe Support block for 3 mm rebate depth
25094800		Klotzbrücke Glazing bridge	violett Violet	250 Stk.	Distanzklotz für 3 mm Falztiefe Spacer block for 3 mm rebate depth
24205900		Entwässerungskappe Drainage cover cap	weiß White	1000 Stk.	—
25089000		Eindrehanke Fixing lug	verzinkt Galvanised	100 Stk.	150 mm lang 150 mm long
25089500				200 mm lang 200 mm long	
25286100				250 mm lang 250 mm long	
25286200				50 Stk.	300 mm lang 300 mm long
28658200		Dämmprofil Blendrahmenrücken Insulation profile for rear of outer frame	—	70 Stk. x 1 m	kann vor Zuschnitt in Profil eingeschoben werden Can be inserted into the profile before cutting
25261300		Fensterfalzlüfter Schüco VentoAir RF LivIng 82 AS Schüco VentoAir RF LivIng 82 AS window rebate fan	weiß White	20 Stk.	Set aus Trägerbauteil, Flügelsystemdichtung grau, Rückstellfeder Kit comprises bracket components, grey vent system gasket, release spring
28687200		Nutabdeckprofil Groove cover profile	weiß White	300 m	Abdeckung der Glasleistennut Covering the glazing bead groove
28687300			cremeweiß Cream white		

Blendrahmen 82/80 AS ■ Outer frame 82/80 AS
19422...

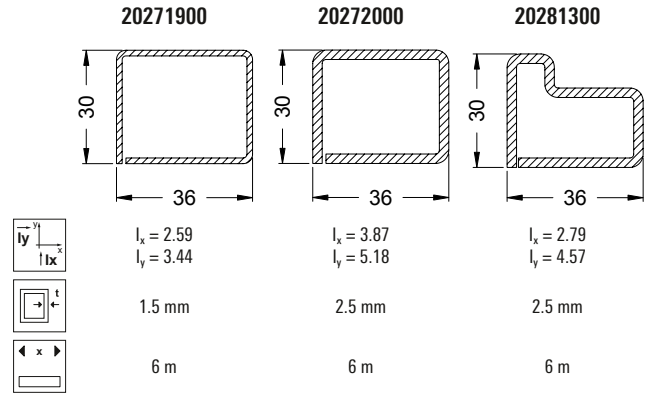
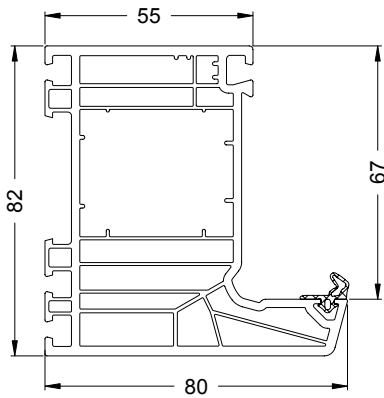

Art.-Nr. Art. No.	Abbildung Illustration	Benennung Description			
25254600		Reparaturdichtung: Anschlag- und Glasanlagedichtung Repair gasket: rebate gasket and glazing rebate gasket	schwarz Black	100 m*	EPDM-Dichtung, polymerisiert, nicht schweißbar EPDM gasket, polymerised, cannot be welded
25254500		Reparaturdichtung: Anschlag- und Glasanlagedichtung Repair gasket: rebate gasket and glazing rebate gasket	silbergrau Silver grey		
25282000		Reparaturdichtung: Anschlag- und Glasanlagedichtung Repair gasket: rebate gasket and glazing rebate gasket	schwarz Black	100 m*	EPDM-Dichtung, nicht polymerisiert, schweißbar EPDM gasket, not polymerised, weldable
25281900		Reparaturdichtung: Anschlag- und Glasanlagedichtung Repair gasket: rebate gasket and glazing rebate gasket	silbergrau Silver grey		
25094900		Klotzbrücke Glazing bridge	braun Brown	250 Stk.	Tragklotz für 3 mm Falztiefe Support block for 3 mm rebate depth
25094800		Klotzbrücke Glazing bridge	violett Violet	250 Stk.	Distanzklotz für 3 mm Falztiefe Spacer block for 3 mm rebate depth
24205900		Entwässerungskappe Drainage cover cap	weiß White	1000 Stk.	—
25089000		Eindrehanke Fixing lug	verzinkt Galvanised	100 Stk.	150 mm lang 150 mm long
25089500					200 mm lang 200 mm long
25286100					250 mm lang 250 mm long
25286200					300 mm lang 300 mm long
28658200		Dämmprofil Blendrahmenrücken Insulation profile for rear of outer frame	—	70 Stk. x 1 m	kann vor Zuschchnitt in Profil eingeschoben werden Can be inserted into the profile before cutting
25261300		Fensterfalzlüfter Schüco VentoAir RF LivIng 82 AS Schüco VentoAir RF LivIng 82 AS window rebate fan	weiß White	20 Stk.	Set aus Trägerbauteil, Flügelsystemdichtung grau, Rückstellfeder Kit comprises bracket components, grey vent system gasket, release spring
28687200		Nutabdeckprofil Groove cover profile	weiß White cremeweiß Cream white	300 m	Abdeckung der Glasleistennut Covering the glazing bead groove
28687300					

Blendrahmen 82/90 AS ■ Outer frame 82/90 AS
19423...

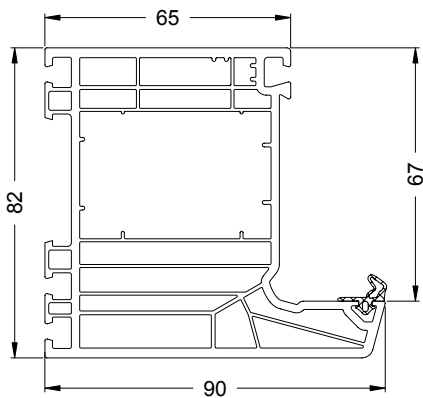

	20272100	20272200	20281400
$I_x = 3.2$ $I_y = 6.21$	$I_x = 4.81$ $I_y = 9.51$	$I_x = 3.75$ $I_y = 8.41$	
1.5 mm	2.5 mm	2.5 mm	
6 m	6 m	6 m	

Art.-Nr. Art. No.	Abbildung Illustration	Benennung Description			
25254600		Reparaturdichtung: Anschlag- und Glasanlagedichtung Repair gasket: rebate gasket and glazing rebate gasket	schwarz Black	100 m*	EPDM-Dichtung, polymerisiert, nicht schweißbar EPDM gasket, polymerised, cannot be welded
25254500			silbergrau Silver grey		
25282000		Reparaturdichtung: Anschlag- und Glasanlagedichtung Repair gasket: rebate gasket and glazing rebate gasket	schwarz Black	100 m*	EPDM-Dichtung, nicht polymerisiert, schweißbar EPDM gasket, not polymerised, weldable
25281900			silbergrau Silver grey		
25094900		Klotzbrücke Glazing bridge	braun Brown	250 Stk.	Tragklotz für 3 mm Falztiefe Support block for 3 mm rebate depth
25094800		Klotzbrücke Glazing bridge	violett Violet	250 Stk.	Distanzklotz für 3 mm Falztiefe Spacer block for 3 mm rebate depth
24205900		Entwässerungskappe Drainage cover cap	weiß White	1000 Stk.	—
25089000		Eindrehanke Fixing lug	verzinkt Galvanised	100 Stk.	150 mm lang 150 mm long
25089500				200 mm lang 200 mm long	
25286100				250 mm lang 250 mm long	
25286200				50 Stk.	300 mm lang 300 mm long
28658200		Dämmprofil Blendrahmenrücken Insulation profile for rear of outer frame	—	70 Stk. x 1 m	kann vor Zuschnitt in Profil eingeschoben werden Can be inserted into the profile before cutting
25261300		Fensterfalzlüfter Schüco VentoAir RF LivIng 82 AS Schüco VentoAir RF LivIng 82 AS window rebate fan	weiß White	20 Stk.	Set aus Trägerbauteil, Flügelsystemdichtung grau, Rückstellfeder Kit comprises bracket components, grey vent system gasket, release spring
28687200		Nutabdeckprofil Groove cover profile	weiß White	300 m	Abdeckung der Glasleistennut Covering the glazing bead groove
28687300			cremeweiß Cream white		

Blendrahmen 82/100 AS ■ Outer frame 82/100 AS
19424...

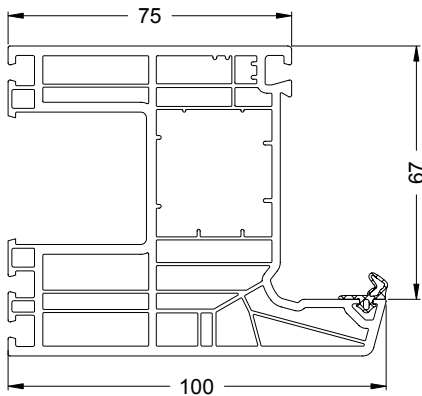

	20271500	20271700	20271800	20281200
$I_x = 1.35$ $I_y = 0.72$	$I_x = 2.01$ $I_y = 1.6$	$I_x = 2.94$ $I_y = 2.33$	$I_x = 1.17$ $I_y = 2$	
1.5 mm	1.5 mm	2.5 mm	2.5 mm	
6 m	6 m	6 m	6 m	

Art.-Nr. Art. No.	Abbildung Illustration	Benennung Description			
25254600		Reparaturdichtung: Anschlag- und Glasanlagendichtung Repair gasket: rebate gasket and glazing rebate gasket	schwarz Black	100 m*	EPDM-Dichtung, polymerisiert, nicht schweißbar EPDM gasket, polymerised, cannot be welded
25254500		Reparaturdichtung: Anschlag- und Glasanlagendichtung Repair gasket: rebate gasket and glazing rebate gasket	silbergrau Silver grey		
25282000		Reparaturdichtung: Anschlag- und Glasanlagendichtung Repair gasket: rebate gasket and glazing rebate gasket	schwarz Black	100 m*	EPDM-Dichtung, nicht polymerisiert, schweißbar EPDM gasket, not polymerised, weldable
25281900		Reparaturdichtung: Anschlag- und Glasanlagendichtung Repair gasket: rebate gasket and glazing rebate gasket	silbergrau Silver grey		
25094900		Klotzbrücke Glazing bridge	braun Brown	250 Stk.	Tragklotz für 3 mm Falztiefe Support block for 3 mm rebate depth
25094800		Klotzbrücke Glazing bridge	violett Violet	250 Stk.	Distanzklotz für 3 mm Falztiefe Spacer block for 3 mm rebate depth
24205900		Entwässerungskappe Drainage cover cap	weiß White	1000 Stk.	—
25089000		Eindrehhanker Fixing lug	verzinkt Galvanised	100 Stk.	150 mm lang 150 mm long
25089500					200 mm lang 200 mm long
25286100					250 mm lang 250 mm long
25286200					300 mm lang 300 mm long
25261300		Fensterfalzlüfter Schüco VentoAir RF LivIng 82 AS Schüco VentoAir RF LivIng 82 AS window rebate fan	weiß White	20 Stk.	Set aus Trägerbauteil, Flügelsystemdichtung grau, Rückstellfeder Kit comprises bracket components, grey vent system gasket, release spring
28687200		Nutabdeckprofil Groove cover profile	weiß White cremeweiß Cream white	300 m	Abdeckung der Glasleistennut Covering the glazing bead groove
28687300					

Türschwelle







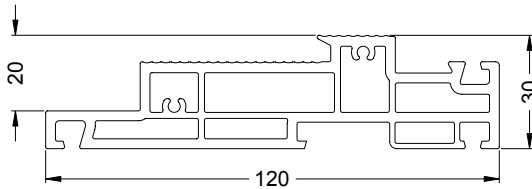



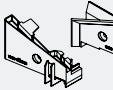
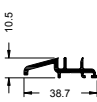

Door threshold

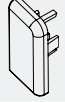
Türschwelle 120 Variant ■ Variant door threshold 120

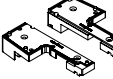
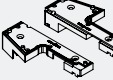
25278200 schwarz ■ Black

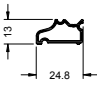
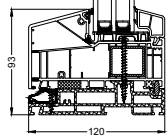

Art.-Nr. Art. No.	Abbildung Illustration	Benennung Description			
17472150		Trittschutz, einwärts Kick plate, inwards	schwarz Black	6,0 m	zur Abdeckung des Türschwelfalzes To cover the door threshold rebate
25061800		Anschlagdichtung Rebate gasket	silbergrau Silver grey	50 m*	Anschlagdichtung für oberen Teil des Flügelrahmens, für auswärts öffnende Türen Rebate gasket for upper part of the leaf frame, for outward-opening doors
25061700		schwarz Black			
25280000		Türschwellerhalter Blendrahmenrücken Door threshold bracket for rear of outer frame	schwarz Black	10 P.	Für Blendrahmen in Kombination mit dem Türschwellerhalter für 15° und 6° For outer frames in combination with the door threshold brackets for 15° and 6°
25279900		Türschwellerhalter 6° Variant Variant door threshold bracket, 6°	schwarz Black	10 P.	Für Blendrahmen 6° in Kombination mit dem Türschwellerhalter Blendrahmenrücken oder als Paar für ein T-Profil 6° For a 6° outer frame in combination with the door threshold bracket for the rear of outer frame or as a pair for a 6° T-profile
25279800		Türschwellerhalter 15° Variant Variant door threshold bracket, 15°	schwarz Black	10 P.	Für Blendrahmen 15° in Kombination mit dem Türschwellerhalter Blendrahmenrücken oder als Paar für ein T-Profil 15° For a 15° outer frame in combination with the door threshold bracket for the rear of outer frame or as a pair for a 15° T-profile
25279700		Türschwellerhalter Wechselprofil 6° Variant Variant door threshold bracket for reverse rebate profile, 6°	schwarz Black	10 P.	Für Wechselprofil 6° in Kombination mit dem Türschwellerhalter Blendrahmenrücken oder Türschwellerhalter 6° For a 6° reverse rebate profile in combination with the door threshold bracket for the rear of outer frame or as a 6° door threshold bracket
25279600		Türschwellerhalter Wechselprofil 15° Variant Variant door threshold bracket for reverse rebate profile, 15°	schwarz Black	10 P.	Für Wechselprofil 15° in Kombination mit dem Türschwellerhalter Blendrahmenrücken oder Türschwellerhalter 15° For a 15° reverse rebate profile in combination with the door threshold bracket for the rear of outer frame or as a 15° door threshold bracket
25279500		Türschwellerhalter nach außen öffnend Door threshold bracket, outward-opening	schwarz Black	10 P.	Für Blendrahmen nach außen öffnend in Kombination mit dem Türschwellerhalter Blendrahmenrücken For a 6° outward-opening outer frame in combination with the door threshold bracket for the rear of outer frame
25286300		Bohrlehre Drilling jig	—	1 Stk.	Für Blendrahmen & Adapter-Wechselprofile LivIng Variant For LivIng Variant outer frames and reverse rebate profiles
25064500		Türschwelledichtung Door threshold gasket	silbergrau Silver grey	5 x 1,20 m	Optionale Dichtung für die Beschlagnut Optional gasket for the fittings groove
14709500		Bürstenaufnahme LivIng Living brush seal groove	roh mill finish	6 m	für innen öffnend (in Kombination mit Wetterschenkel) und außen öffnend (ohne Wetterschenkel) For inward-opening (in conjunction with drip bar) and outward-opening (without drip bar)
14709510			weiß White		
14709560			E6/EV1		
14709570			schwarz Black		

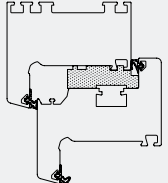
Art.-Nr. Art. No.	Abbildung Illustration	Benennung Description			
25266200		Dichtset AS	schwarz Black	5 Stk.	Inhalt des Sets ist je ein linker und ein rechter Windstopp für den Blendrahmen und den Flügelrahmen (dargestellt ist je ein rechtes Teil) Each set contains a left-hand and right-hand wind stop for the outer frame and the vent frame (a right-hand component is shown in each case)
25266300		AS seal kit	silbergrau Silver grey		
14709600		Alu-Wetterschenkel 38,7/10,5 LivIng Aluminium drip bar 38.7/10.5 Living	roh mill finish	6 m	
14709610			weiß White		
14709660			E6/EV1		
14709670			schwarz Black		
28634100		Endkappe End cap	weiß White	5 P.	Hinweis: Weitere Wetterschenkel, Endkappen und Zubehör befinden sich im Schüco Zusatzprofile-Katalog. 75838 Note: Further drip bars, end caps and accessories can be found in the Schüco supplementary profiles manual. 75838
28696400			cremeweiß Cream white		
28634200			schwarz Black		
17494...		Wetterschenkel 19,5/32 Drip bar 19.5/32	—	6,0 m	
21794600		Dicht- bzw. Endkappe Sealing/end cap	weiß White	25 P.	
11394900		Alu-Adapter 10/4, gelocht (roh) Aluminium adapter 10/4, pre-punched (mill finish)	roh mill finish	6,0 m	
28699300		Bürstendichtung 9 Brush seal 9	schwarz Black	100 m*	Einsatz als Dichtung für Türschwellen bei 15 mm Bodenabstand (Abstand Flügelunterkante zur Oberkante Fertigfußboden) Use as gasket for door thresholds with 15 mm ground clearance (distance from bottom edge of the leaf to finished floor level)
Mehrteilige Elemente Multi-part units					
25279900		Türschwellenhalter 6° Variant Variant door threshold bracket, 6°	schwarz Black	10 P.	Paar für ein T-Profil 6° Pair for a 6° T-profile
25279800		Türschwellenhalter 15° Variant Variant door threshold bracket, 15°	schwarz Black	10 P.	Paar für ein T-Profil 15° Pair for a 15° T-profile
25286400		Bohrlehre Drilling jig	—	1 Stk.	Für T-Profile & Wechselprofile LivIng Variant For LivIng Variant T-profiles and reverse rebate profiles
29844000		Komprimband 20 x 6 Compression tape 20 x 6	—	28 m	Zur Abdichtung der unteren Aufbau- bzw. Ausgleichsprofile sowie verschraubter Flügelrahmen For sealing the lower add-on profiles or spacer profiles and leaf frames with screw fixing
14740800		Ausgleichsprofil LivIng Variant LivIng Variant spacer profile	roh mill finish	6 m	
14740870			schwarz Black		
25287800		Endkappe 15° End cap, 15°	schwarz Black	10 P.	für Ausgleichsprofil 15° for 15° spacer profile
25287700		Endkappe 6° End cap, 6°			für Ausgleichsprofil 6° for 6° spacer profile
19344000		Passfeder 4/13 Spring pin 4/13	weiß White	6,0 m	Arretierung des Aufbauprofils Securing the add-on profile
23752200		Distanzstück Spacer	schwarz Black	20 Stk.	

Art.-Nr. Art. No.	Abbildung Illustration	Benennung Description			
—		Distanzklotz Spacer block	28 x 12 28 x 14	—	
Stulp-Türen Double-leaf doors					
25088500		Distanzstück Spacer	schwarz Black	20 Stk.	für Dreh/Kipp for turn/tilt
25266800		Stulp Set LivIng 82 AS - RS	schwarz Black	5 Stk.	Inhalt des Sets ist je ein Windstopp für den Stulp und ein Windstopp für den Flügelrahmen Each set contains a wind stop for the meeting stile and a wind stop for the leaf frame
25267000		LivIng 82 AS meeting stile kit - RS	silbergrau Silver grey		
25266900		Stulp Set LivIng 82 AS - LS	schwarz Black	5 Stk.	Inhalt des Sets ist je ein Windstopp für den Stulp und ein Windstopp für den Flügelrahmen Each set contains a wind stop for the meeting stile and a wind stop for the leaf frame
25267100		LivIng 82 AS meeting stile kit - LS	silbergrau Silver grey		
25883400		Endkappe End cap	schwarz Black	5 P.	zur Arretierung der Bürstendichtung bei nach außen öffnenden Flügeln For retaining the brush seal on outward-opening vents
25883300			silbergrau Silver grey		
Zusatzprofile Supplementary profiles					
19256...		Blendrahmenverbreiterung 82/25 5K Outer frame extension 82/25 5K	foliert Foiled	6 m	—
19257...		Blendrahmenverbreiterung 82/50 5K Outer frame extension 82/50 5K	foliert Foiled	6 m	—
19258...		Blendrahmenverbreiterung 82/120 5K Outer frame extension 82/120 5K	foliert Foiled	6 m	—
19051...		Anschlussprofil 12,5/20 mit Dichtung Attachment profile 12.5/20 with gasket	foliert Foiled	6 m	—
19051150			schwarz Black	6 m	
Zubehör Accessories					
—		—	—	—	Hinweis: Weitere Wetterschenkel, Endkappen und Zubehör befinden sich im Schüco Zusatzprofile-Katalog. 75838 Note: Further drip bars, end caps and accessories can be found in the Schüco supplementary profiles manual. 75838

Anschlussmöglichkeiten 25278200

Attachment options 25278200

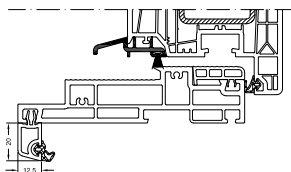
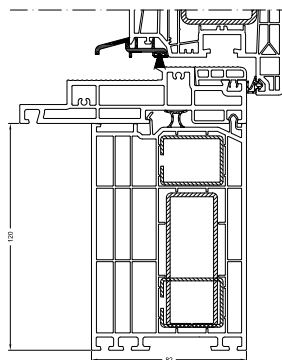
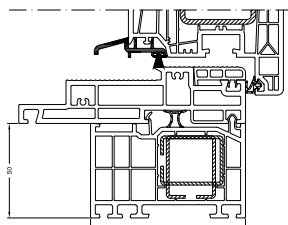
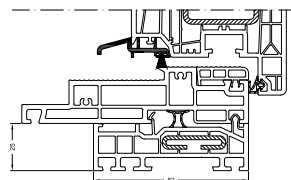

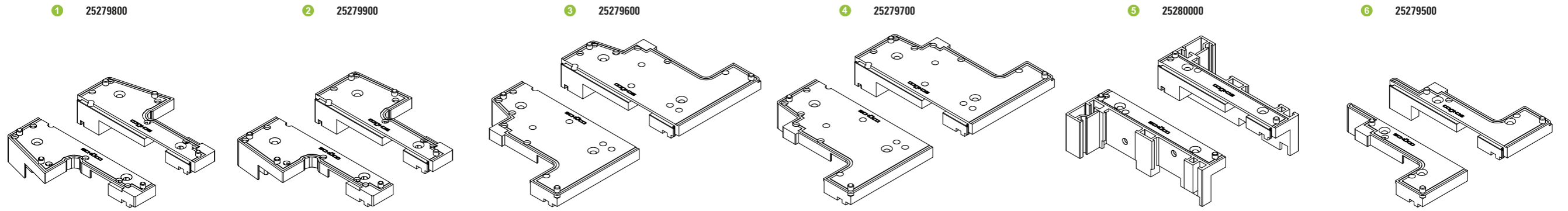

Türschwellerhalter (Kombinationen) für die rechte Türschwelleseite ■ Door threshold bracket (combinations) for the right-hand side of the door threshold

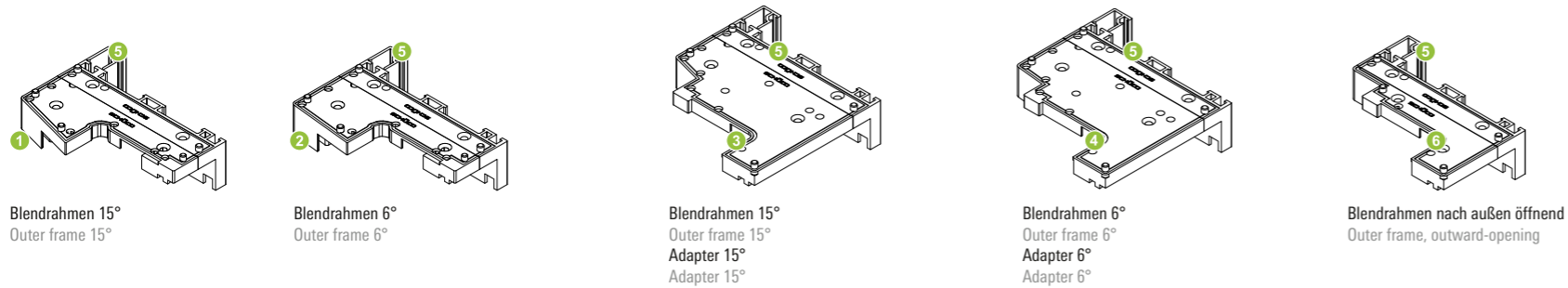

Türschwellerhalter (Kombinationen) für die linke Türschwelleseite ■ Door threshold bracket (combinations) for the left-hand side of the door threshold

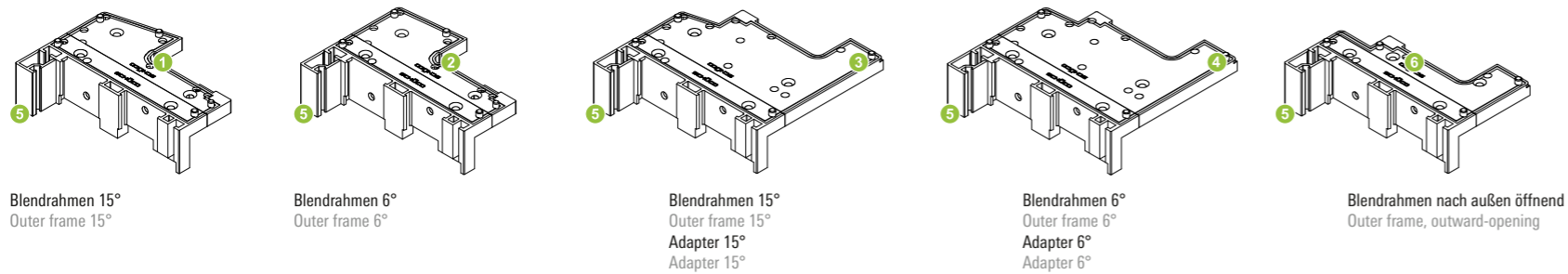

Türschwellerhalter (Kombinationen) für das T-Profil ■ Door threshold bracket (combinations) for the T-profile

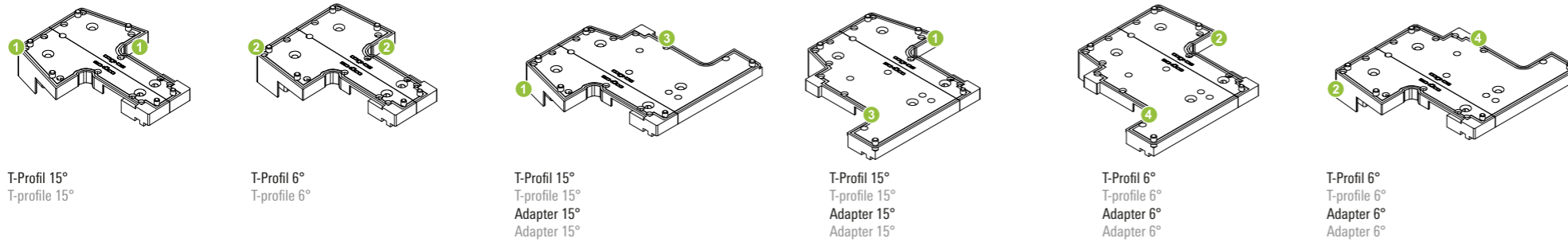

Türschwellerhalter (Kombinationen) für das Wechselprofil ■ Door threshold bracket (combinations) for the reverse rebate profile

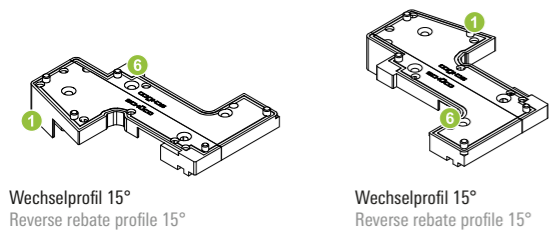

Flügelrahmen Vent frame

TA 03.2018

Art.-Nr. Art. No.	Abbildung Illustration	Benennung Description			
19430...		Flügelrahmen 82/73 Vent frame 82/73	AS MD		51
19431...		Flügelrahmen 82/83 Vent frame 82/83	AS MD		52
19434...		Flügelrahmen 82/83 Klebeflügel vent frame 82/83 for adhesive vent	AS MD		53
19432...		Flügelrahmen 82/110 Vent frame 82/110	AS MD	NET AS	54
19452...		Flügelrahmen 82/110 nach außen öffnend Vent frame 82/110, outward-opening	—	NET AS	55
19433...		Flügelrahmen 82/125 Vent frame 82/125	—	HT AS	56
19439...		Aufbauprofil 82/119.5 Built-on profile 82/119.5	—	HT AS	57

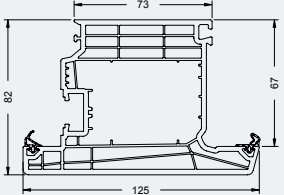
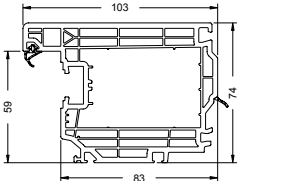
Art.-Nr. Art. No.	Abbildung Illustration	Benennung Description			
19453...		Flügelrahmen 82/125 nach außen öffnend Vent frame 82/125, outward-opening	—	HT AS	58
19435...		Flügelrahmen 82/103 Vent frame 82/103	—	HT AS	59

Flügelrahmen 82/73 ■ Vent frame 82/73
19430...

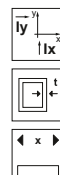
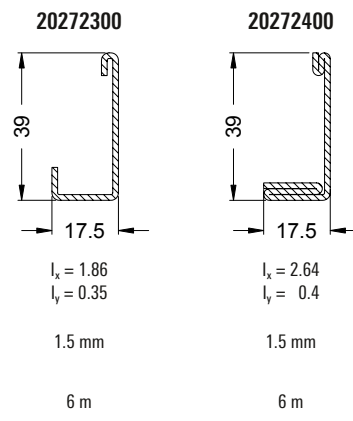
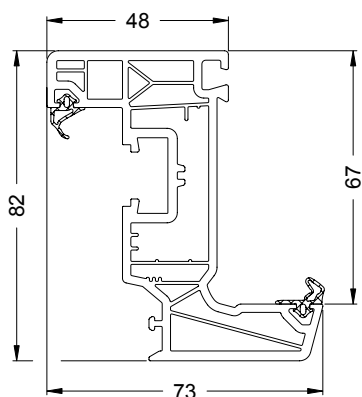

Art.-Nr. Art. No.	Abbildung Illustration	Benennung Description			
25254600		Reparaturdichtung: Anschlag- und Glasanlegedichtung Repair gasket: rebate gasket and glazing rebate gasket	schwarz Black	100 m*	EPDM-Dichtung, polymerisiert, nicht schweißbar EPDM gasket, polymerised, cannot be welded
25254500			silbergrau Silver grey		
25282000		Reparaturdichtung: Anschlag- und Glasanlegedichtung Repair gasket: rebate gasket and glazing rebate gasket	schwarz Black	100 m*	EPDM-Dichtung, nicht polymerisiert, schweißbar EPDM gasket, not polymerised, weldable
25281900			silbergrau Silver grey		
25255000		Reparaturdichtung: Flügelanschlagdichtung Repair gasket: leaf rebate gasket	schwarz Black	100 m*	EPDM-Dichtung, polymerisiert, nicht schweißbar EPDM gasket, polymerised, cannot be welded
25254900			silbergrau Silver grey		
25282200		Reparaturdichtung: Flügelanschlagdichtung Repair gasket: leaf rebate gasket	schwarz Black	100 m*	EPDM-Dichtung, nicht polymerisiert, schweißbar EPDM gasket, not polymerised, weldable
25282100			silbergrau Silver grey		
25094900		Klotzbrücke Glazing bridge	braun Brown	250 Stk.	Tragklotz für 3 mm Falztiefe Support block for 3 mm rebate depth
25094800		Klotzbrücke Glazing bridge	violett Violet	250 Stk.	Distanzklotz für 3 mm Falztiefe Spacer block for 3 mm rebate depth
25264700		Dämmfalzeinleger 67 LivIng LivIng insulating rebate insert 67	—	80 m	—
19640000		Falzeinlage 67/3 Rebate insert 67/3	weiß White	3 x 6 m	Einsetzbar bei Schüco LivIng Can be used with Schüco LivIng

Flügelrahmen 82/83 ■ Vent frame 82/83
19431...

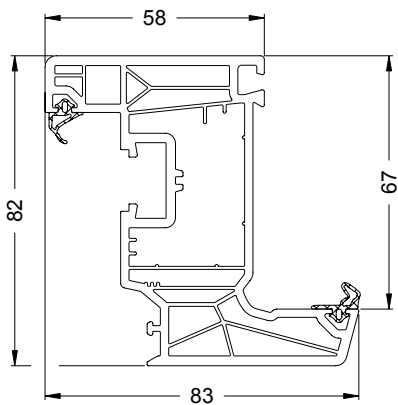

20271500

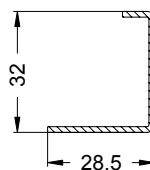

$I_x = 1.35$
 $I_y = 0.72$

1.5 mm

6 m

20272500

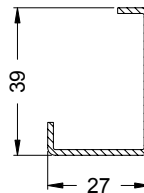

$I_x = 2.22$
 $I_y = 1$

1.5 mm

6 m

20272600

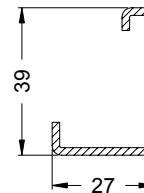

$I_x = 3.07$
 $I_y = 1.25$

2 mm

6 m

20272700

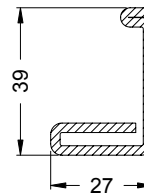

$I_x = 4.09$
 $I_y = 1.74$

2.5 mm

6 m



Art.-Nr. Art. No.	Abbildung Illustration	Benennung Description			
25254600		Reparaturdichtung: Anschlag- und Glasanlagedichtung Repair gasket: rebate gasket and glazing rebate gasket	schwarz Black	100 m*	EPDM-Dichtung, polymerisiert, nicht schweißbar EPDM gasket, polymerised, cannot be welded
25254500			silbergrau Silver grey		
25282000		Reparaturdichtung: Anschlag- und Glasanlagedichtung Repair gasket: rebate gasket and glazing rebate gasket	schwarz Black	100 m*	EPDM-Dichtung, nicht polymerisiert, schweißbar EPDM gasket, not polymerised, weldable
25281900			silbergrau Silver grey		
25255000		Reparaturdichtung: Flügelanschlagdichtung Repair gasket: leaf rebate gasket	schwarz Black	100 m*	EPDM-Dichtung, polymerisiert, nicht schweißbar EPDM gasket, polymerised, cannot be welded
25254900			silbergrau Silver grey		
25282200		Reparaturdichtung: Flügelanschlagdichtung Repair gasket: leaf rebate gasket	schwarz Black	100 m*	EPDM-Dichtung, nicht polymerisiert, schweißbar EPDM gasket, not polymerised, weldable
25282100			silbergrau Silver grey		
25094900		Klotzbrücke Glazing bridge	braun Brown	250 Stk.	Tragklotz für 3 mm Falztiefe Support block for 3 mm rebate depth
25094800		Klotzbrücke Glazing bridge	violett Violet	250 Stk.	Distanzklotz für 3 mm Falztiefe Spacer block for 3 mm rebate depth
25264700		Dämmfalzeinleger 67 LivIng LivIng insulating rebate insert 67	—	80 m	—
19640000		Falzeinlage 67/3 Rebate insert 67/3	weiß White	3 x 6 m	Einsetzbar bei Schüco LivIng Can be used with Schüco LivIng

Flügelrahmen 82/83 Klebeflügel ■ Vent frame 82/83 for adhesive vent
19434...

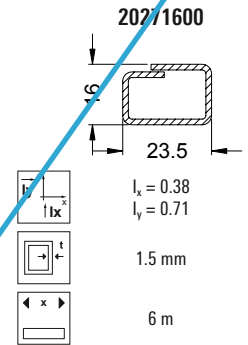
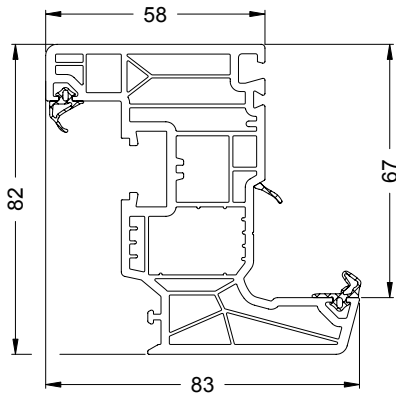

Art.-Nr. Art. No.	Abbildung Illustration	Benennung Description			
25254600		Reparaturdichtung: Anschlag- und Glasanlegedichtung Repair gasket: rebate gasket and glazing rebate gasket	schwarz Black	100 m*	EPDM-Dichtung, polymerisiert, nicht schweißbar EPDM gasket, polymerised, cannot be welded
25254500		Reparaturdichtung: Anschlag- und Glasanlegedichtung Repair gasket: rebate gasket and glazing rebate gasket	silbergrau Silver grey		
25282000		Reparaturdichtung: Anschlag- und Glasanlegedichtung Repair gasket: rebate gasket and glazing rebate gasket	schwarz Black	100 m*	EPDM-Dichtung, nicht polymerisiert, schweißbar EPDM gasket, not polymerised, weldable
25281900		Reparaturdichtung: Anschlag- und Glasanlegedichtung Repair gasket: rebate gasket and glazing rebate gasket	silbergrau Silver grey		
25255000		Reparaturdichtung: Flügelanschlagdichtung Repair gasket: leaf rebate gasket	schwarz Black	100 m*	EPDM-Dichtung, polymerisiert, nicht schweißbar EPDM gasket, polymerised, cannot be welded
25254900		Reparaturdichtung: Flügelanschlagdichtung Repair gasket: leaf rebate gasket	silbergrau Silver grey		
25282200		Reparaturdichtung: Flügelanschlagdichtung Repair gasket: leaf rebate gasket	schwarz Black	100 m*	EPDM-Dichtung, nicht polymerisiert, schweißbar EPDM gasket, not polymerised, weldable
25282100		Reparaturdichtung: Flügelanschlagdichtung Repair gasket: leaf rebate gasket	silbergrau Silver grey		
25096600		Klotzbrücke Glazing bridge	dunkelblau Dark blue	250 Stk.	Tragklotz für 0 mm Falztiefe Support block for 0 mm rebate depth
28653500		Distanzstück 11 mm Spacer 11 mm	gelb Yellow	20 Stk.	Die Distanzstücke werden bei der Verglasung im Flügelrahmen in den Blendrahmen eingesetzt und anschließend wieder entfernt. The spacers are inserted into the outer frame during glazing of the vent frame, and then removed.
28645400		Distanzstück 12 mm Spacer 12 mm	grün Green	100 Stk.	Die Distanzstücke werden bei der Verglasung im Flügelrahmen in den Blendrahmen eingesetzt und anschließend wieder entfernt. The spacers are inserted into the outer frame during glazing of the vent frame, and then removed.
28645500		Distanzstück 13 mm Spacer 13 mm	rot Red	20 Stk.	Die Distanzstücke werden bei der Verglasung im Flügelrahmen in den Blendrahmen eingesetzt und anschließend wieder entfernt. The spacers are inserted into the outer frame during glazing of the vent frame, and then removed.

Hinweise:

Empfohlene Primer und Klebstoffe, siehe Kapitel Verkleben (Additive Klebetechnik).

Schüco LivIng 76600

Note:

For recommended primer and adhesives, see the "Bonding" chapter (Additive adhesive technology).

Schüco LivIng 76600

Flügelrahmen 82/110 ■ Vent frame 82/110
19432...

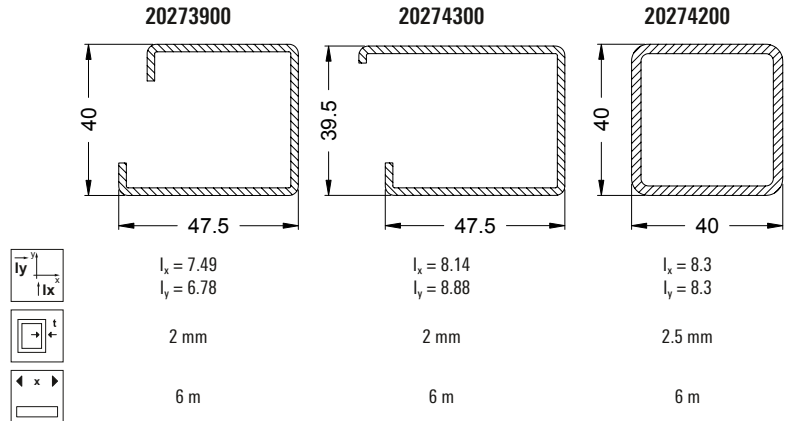
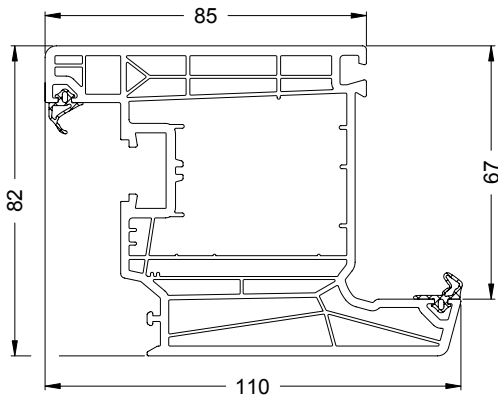

Art.-Nr. Art. No.	Abbildung Illustration	Benennung Description			
25254600		Reparaturdichtung: Anschlag- und Glasanlagedichtung Repair gasket: rebate gasket and glazing rebate gasket	schwarz Black	100 m*	EPDM-Dichtung, polymerisiert, nicht schweißbar EPDM gasket, polymerised, cannot be welded
25254500			silbergrau Silver grey		
25282000		Reparaturdichtung: Anschlag- und Glasanlagedichtung Repair gasket: rebate gasket and glazing rebate gasket	schwarz Black	100 m*	EPDM-Dichtung, nicht polymerisiert, schweißbar EPDM gasket, not polymerised, weldable
25281900			silbergrau Silver grey		
25255000		Reparaturdichtung: Flügelanschlagdichtung Repair gasket: leaf rebate gasket	schwarz Black	100 m*	EPDM-Dichtung, polymerisiert, nicht schweißbar EPDM gasket, polymerised, cannot be welded
25254900			silbergrau Silver grey		
25282200		Reparaturdichtung: Flügelanschlagdichtung Repair gasket: leaf rebate gasket	schwarz Black	100 m*	EPDM-Dichtung, nicht polymerisiert, schweißbar EPDM gasket, not polymerised, weldable
25282100			silbergrau Silver grey		
25094900		Klotzbrücke Glazing bridge	braun Brown	250 Stk.	Tragklotz für 3 mm Falztiefe Support block for 3 mm rebate depth
25094800		Klotzbrücke Glazing bridge	violett Violet	250 Stk.	Distanzklotz für 3 mm Falztiefe Spacer block for 3 mm rebate depth
28617400		Eckverbinder, schweißbar Corner cleat, weldable	—	8 Stk.	Einsatz mit Verstärkung: 20274200 For use with reinforcement: 20274200
28254600		Spannhebel Clamping lever	—	1 Stk.	—
25264700		Dämmfalzeinleger 67 LivIng LivIng insulating rebate insert 67	—	80 m	—
19640000		Falzeinlage 67/3 Rebate insert 67/3	weiß White	3 x 6 m	Einsetzbar bei Schüco LivIng Can be used with Schüco LivIng

Flügelrahmen 82/110 nach außen öffnend ■ Vent frame 82/110, outward-opening
19452...

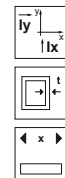
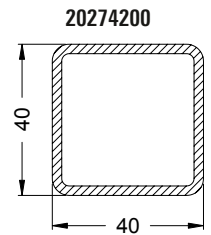
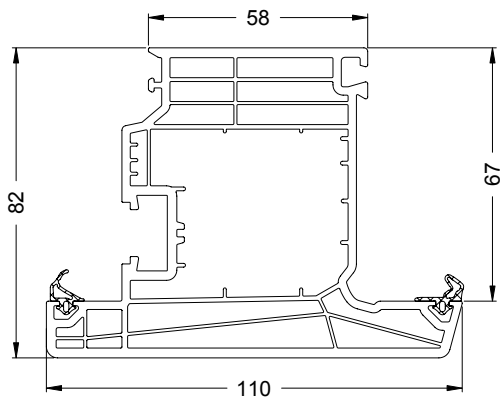

20274200
l_x = 8.3
l_y = 8.3
2.5 mm
6 m

Art.-Nr. Art. No.	Abbildung Illustration	Benennung Description			
25254600		Reparaturdichtung: Anschlag- und Glasanlegedichtung Repair gasket: rebate gasket and glazing rebate gasket	schwarz Black	100 m*	EPDM-Dichtung, polymerisiert, nicht schweißbar EPDM gasket, polymerised, cannot be welded
25254500		Reparaturdichtung: Anschlag- und Glasanlegedichtung Repair gasket: rebate gasket and glazing rebate gasket	silbergrau Silver grey		
25282000		Reparaturdichtung: Anschlag- und Glasanlegedichtung Repair gasket: rebate gasket and glazing rebate gasket	schwarz Black	100 m*	EPDM-Dichtung, nicht polymerisiert, schweißbar EPDM gasket, not polymerised, weldable
25281900		Reparaturdichtung: Anschlag- und Glasanlegedichtung Repair gasket: rebate gasket and glazing rebate gasket	silbergrau Silver grey		
25255000		Reparaturdichtung: Flügelanschlagdichtung Repair gasket: leaf rebate gasket	schwarz Black	100 m*	EPDM-Dichtung, polymerisiert, nicht schweißbar EPDM gasket, polymerised, cannot be welded
25254900		Reparaturdichtung: Flügelanschlagdichtung Repair gasket: leaf rebate gasket	silbergrau Silver grey		
25282200		Reparaturdichtung: Flügelanschlagdichtung Repair gasket: leaf rebate gasket	schwarz Black	100 m*	EPDM-Dichtung, nicht polymerisiert, schweißbar EPDM gasket, not polymerised, weldable
25282100		Reparaturdichtung: Flügelanschlagdichtung Repair gasket: leaf rebate gasket	silbergrau Silver grey		
25061800		Anschlagdichtung Rebate gasket	silbergrau Silver grey	50 m*	Anschlagdichtung für oberen Teil des Flügelrahmens, für auswärts öffnende Türen Rebate gasket for upper part of the leaf frame, for out- ward-opening doors
25061700		Anschlagdichtung Rebate gasket	schwarz Black		
25094900		Klotzbrücke Glazing bridge	braun Brown	250 Stk.	Tragklotz für 3 mm Falztiefe Support block for 3 mm rebate depth
25094800		Klotzbrücke Glazing bridge	violett Violet	250 Stk.	Distanzklotz für 3 mm Falztiefe Spacer block for 3 mm rebate depth
28617400		Eckverbinder, schweißbar Corner cleat, weldable	—	8 Stk.	Einsatz mit Verstärkung: 20274200 For use with reinforcement: 20274200
28254600		Spannhebel Clamping lever	—	1 Stk.	—
25264700		Dämmfalzeinleger 67 LivIng LivIng insulating rebate insert 67	—	80 m	—
19640000		Falzeinlage 67/3 Rebate insert 67/3	weiß White	3 x 6 m	Einsetzbar bei Schüco LivIng Can be used with Schüco LivIng

Flügelrahmen 82/125 ■ Vent frame 82/125

19433... Lieferlänge: 6,5 m ■ Stock length: 6.5 m

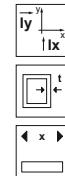
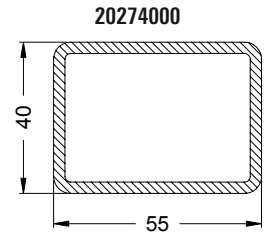
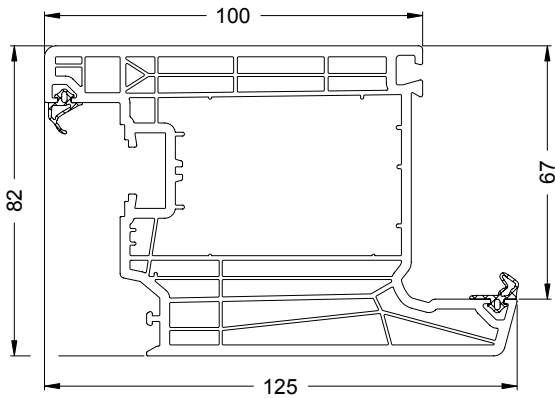

20274000
 $I_x = 12.71$
 $I_y = 21.02$
3 mm
6 m

Art.-Nr. Art. No.	Abbildung Illustration	Benennung Description			
25254600		Reparaturdichtung: Anschlag- und Glasanlagedichtung Repair gasket: rebate gasket and glazing rebate gasket	schwarz Black	100 m*	EPDM-Dichtung, polymerisiert, nicht schweißbar EPDM gasket, polymerised, cannot be welded
25254500		Reparaturdichtung: Anschlag- und Glasanlagedichtung Repair gasket: rebate gasket and glazing rebate gasket	silbergrau Silver grey		
25282000		Reparaturdichtung: Anschlag- und Glasanlagedichtung Repair gasket: rebate gasket and glazing rebate gasket	schwarz Black	100 m*	EPDM-Dichtung, nicht polymerisiert, schweißbar EPDM gasket, not polymerised, weldable
25281900		Reparaturdichtung: Anschlag- und Glasanlagedichtung Repair gasket: rebate gasket and glazing rebate gasket	silbergrau Silver grey		
25255000		Reparaturdichtung: Flügelanschlagdichtung Repair gasket: leaf rebate gasket	schwarz Black	100 m*	EPDM-Dichtung, polymerisiert, nicht schweißbar EPDM gasket, polymerised, cannot be welded
25254900		Reparaturdichtung: Flügelanschlagdichtung Repair gasket: leaf rebate gasket	silbergrau Silver grey		
25282200		Reparaturdichtung: Flügelanschlagdichtung Repair gasket: leaf rebate gasket	schwarz Black	100 m*	EPDM-Dichtung, nicht polymerisiert, schweißbar EPDM gasket, not polymerised, weldable
25282100		Reparaturdichtung: Flügelanschlagdichtung Repair gasket: leaf rebate gasket	silbergrau Silver grey		
25094900		Klotzbrücke Glazing bridge	braun Brown	250 Stk.	Tragklotz für 3 mm Falztiefe Support block for 3 mm rebate depth
25094800		Klotzbrücke Glazing bridge	violett Violet	250 Stk.	Distanzklotz für 3 mm Falztiefe Spacer block for 3 mm rebate depth
25237500		Eckverbinder, schweißbar Corner cleat, weldable	—	8 Stk.	einsetzbar mit Verstärkungsprofil 20274000 Can be used with reinforcing profile 20274000
25237600			—	128 Stk.	
28254600		Spannhebel Clamping lever	—	1 Stk.	—
25264700		Dämmfalzeinleger 67 LivIng LivIng insulating rebate insert 67	—	80 m	—
19640000		Falzeinlage 67/3 Rebate insert 67/3	weiß White	3 x 6 m	Einsetzbar bei Schüco LivIng Can be used with Schüco LivIng

Aufbauprofil 82/119.5 ■ Built-on profile 82/119.5
19439...

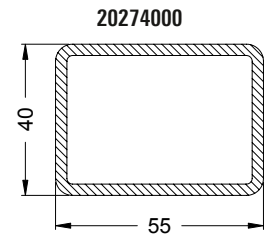
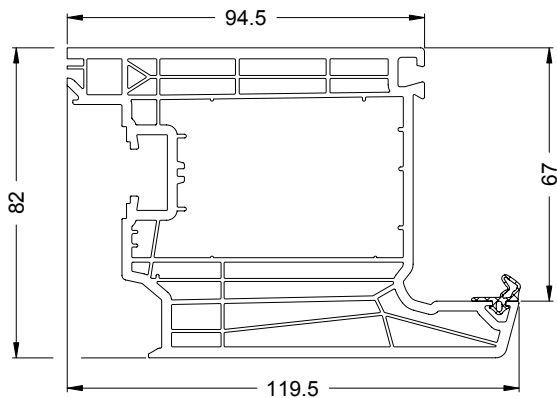

$I_x = 12.71$
 $I_y = 21.02$



3 mm



6 m

Profile
Profiles

Art.-Nr. Art. No.	Abbildung Illustration	Benennung Description			
25254600		Reparaturdichtung: Anschlag- und Glasanlagendichtung Repair gasket: rebate gasket and glazing rebate gasket	schwarz Black	100 m*	EPDM-Dichtung, polymerisiert, nicht schweißbar EPDM gasket, polymerised, cannot be welded
25254500		Reparaturdichtung: Anschlag- und Glasanlagendichtung Repair gasket: rebate gasket and glazing rebate gasket	silbergrau Silver grey		
25282000		Reparaturdichtung: Anschlag- und Glasanlagendichtung Repair gasket: rebate gasket and glazing rebate gasket	schwarz Black	100 m*	EPDM-Dichtung, nicht polymerisiert, schweißbar EPDM gasket, not polymerised, weldable
25281900		Reparaturdichtung: Anschlag- und Glasanlagendichtung Repair gasket: rebate gasket and glazing rebate gasket	silbergrau Silver grey		
25094900		Klotzbrücke Glazing bridge	braun Brown	250 Stk.	Tragklotz für 3 mm Falztiefe Support block for 3 mm rebate depth
25094800		Klotzbrücke Glazing bridge	violett Violet	250 Stk.	Distanzklotz für 3 mm Falztiefe Spacer block for 3 mm rebate depth
25237500		Eckverbinder, schweißbar Corner cleat, weldable	—	8 Stk.	einsetzbar mit Verstärkungsprofil 20274000 Can be used with reinforcing profile 20274000
25237600		Eckverbinder, schweißbar Corner cleat, weldable	—	128 Stk.	
28254600		Spannhebel Clamping lever	—	1 Stk.	—
25264700		Dämmfalzeinleger 67 LivIng LivIng insulating rebate insert 67	—	80 m	—
19640000		Falzeinlage 67/3 Rebate insert 67/3	weiß White	3 x 6 m	Einsetzbar bei Schüco LivIng Can be used with Schüco LivIng
25270400		Verbinder Aufbauprofil Connector for built-on profile	schwarz Black	20 Stk.	—
25246100		Bohrlehre Aufbauprofil Drilling jig for built-on profile	—	1 Stk.	Zur seitlichen Verschraubung des Verbinders Aufbauprofil im Blendrahmen-, Flügelrahmen- und T-Profil For laterally screwing the built-on profile of the cleat in the outer frame, vent and T-profile

Flügelrahmen 82/125 nach außen öffnend ■ Vent frame 82/125, outward-opening



19453... Lieferlänge: 6,5 m ■ Stock length: 6.5 m

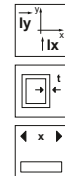
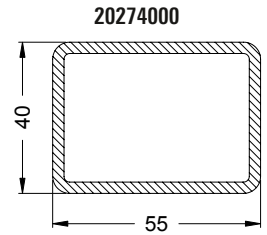
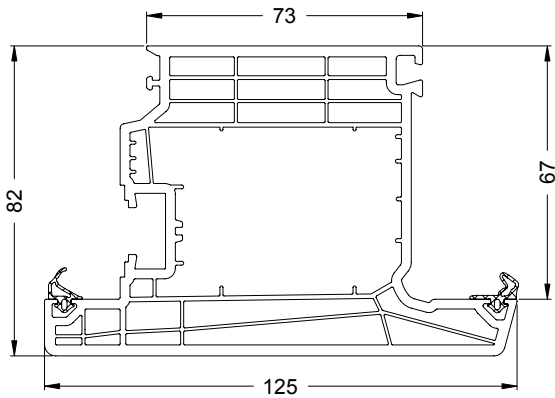

$I_x = 12.71$
 $I_y = 21.02$
3 mm
6 m

Art.-Nr. Art. No.	Abbildung Illustration	Benennung Description			
25254600		Reparaturdichtung: Anschlag- und Glasanlagedichtung Repair gasket: rebate gasket and glazing rebate gasket	schwarz Black	100 m*	EPDM-Dichtung, polymerisiert, nicht schweißbar EPDM gasket, polymerised, cannot be welded
25254500			silbergrau Silver grey		
25282000		Reparaturdichtung: Anschlag- und Glasanlagedichtung Repair gasket: rebate gasket and glazing rebate gasket	schwarz Black	100 m*	EPDM-Dichtung, nicht polymerisiert, schweißbar EPDM gasket, not polymerised, weldable
25281900			silbergrau Silver grey		
25255000		Reparaturdichtung: Flügelanschlagdichtung Repair gasket: leaf rebate gasket	schwarz Black	100 m*	EPDM-Dichtung, polymerisiert, nicht schweißbar EPDM gasket, polymerised, cannot be welded
25254900			silbergrau Silver grey		
25282200		Reparaturdichtung: Flügelanschlagdichtung Repair gasket: leaf rebate gasket	schwarz Black	100 m*	EPDM-Dichtung, nicht polymerisiert, schweißbar EPDM gasket, not polymerised, weldable
25282100			silbergrau Silver grey		
25061800		Anschlagdichtung Rebate gasket	silbergrau Silver grey	50 m*	Anschlagdichtung für oberen Teil des Flügelrahmens, für auswärts öffnende Türen Rebate gasket for upper part of the leaf frame, for out- ward-opening doors
25061700			schwarz Black		
25094900		Klotzbrücke Glazing bridge	braun Brown	250 Stk.	Tragklotz für 3 mm Falztiefe Support block for 3 mm rebate depth
25094800		Klotzbrücke Glazing bridge	violett Violet	250 Stk.	Distanzklotz für 3 mm Falztiefe Spacer block for 3 mm rebate depth
25237500		Eckverbinder, schweißbar Corner cleat, weldable	—	8 Stk.	einsetzbar mit Verstärkungsprofil 20274000 Can be used with reinforcing profile 20274000
25237600			—	128 Stk.	
28254600		Spannhebel Clamping lever	—	1 Stk.	—
25264700		Dämmfalzeinleger 67 LivIng LivIng insulating rebate insert 67	—	80 m	—
19640000		Falzeinlage 67/3 Rebate insert 67/3	weiß White	3 x 6 m	Einsetzbar bei Schüco LivIng Can be used with Schüco LivIng

Flügelrahmen 82/103 ■ Vent frame 82/103
19435... Lieferlänge: 6,5 m ■ Stock length: 6.5 m

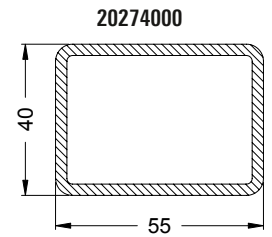
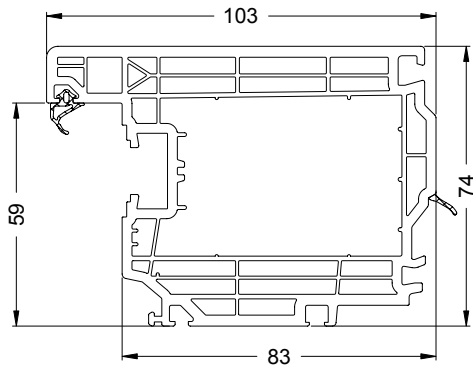

$l_x = 12.71$
 $l_y = 21.02$



3 mm



6 m

Art.-Nr. Art. No.	Abbildung Illustration	Benennung Description			
25255000		Reparaturdichtung: Flügelanschlagdichtung Repair gasket: leaf rebate gasket	schwarz Black	100 m*	EPDM-Dichtung, polymerisiert, nicht schweißbar EPDM gasket, polymerised, cannot be welded
25254900			silbergrau Silver grey		
25282200		Reparaturdichtung: Flügelanschlagdichtung Repair gasket: leaf rebate gasket	schwarz Black	100 m*	EPDM-Dichtung, nicht polymerisiert, schweißbar EPDM gasket, not polymerised, weldable
25282100			silbergrau Silver grey		
25237500		Eckverbinder, schweißbar Corner cleat, weldable	—	8 Stk.	einsetzbar mit Verstärkungsprofil 20274000 Can be used with reinforcing profile 20274000
25237600			—	128 Stk.	
28254600		Spannhebel Clamping lever	—	1 Stk.	—
14705500		Alu-Befestigungswinkel 69/12 Aluminium fixing bracket 69/12	roh mill finish	6 m	optional: zum Aufkleben auf das Türfüllungspaneel Optional: you can bond it to the door infill panel yourself
14705800		Klemmwinkel 18/23 Clamping angle 18/23	schwarz Black	6 m	—
14731600		Alu-Wetterschenkel 41,5/10,5 Aluminium drip bar 41.5/10.5	roh mill finish	6 m	für flügelüberdeckende Türfüllung For leaf-enclosing door infill
14731610			weiß White		
14731670			schwarz Black		
14731660			E6/EV1		
22488900		Verglasungsdichtung Glazing gasket	silbergrau Silver grey	100 m*	zum Einsetzen in das Flügelprofil für flügelüberdeckende Türfüllung For use in the leaf profile for the leaf-enclosing door infill
22452500			schwarz Black		

T-Profile und Sprossen

T-profiles and sash bars

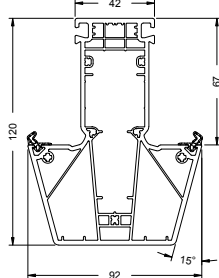
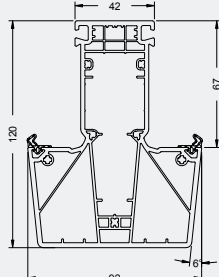
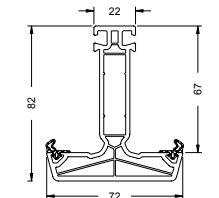
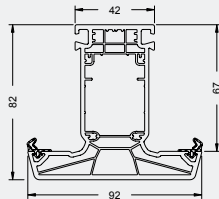
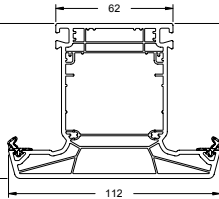
Art.-Nr. Art. No.	Abbildung Illustration	Benennung Description		
19468...		T-Profil 120/92 Variant 15° Variant T-profile 120/92, 15°	AS	62
19469...		T-Profil 120/92 Variant 6° Variant T-profile 120/92, 6°	AS	63
19460...		Flügelprosse 82/72 Vent sash bar 82/72	AS MD	64
19461...		T-Profil 82/92 AS T-profile 82/92 AS	AS MD	65
19462... 19463160		T-Profil 82/112 AS T-profile 82/112 AS	AS	66

T-Profil 120/92 Variant 15° ■ Variant T-profile 120/92, 15°
19468...

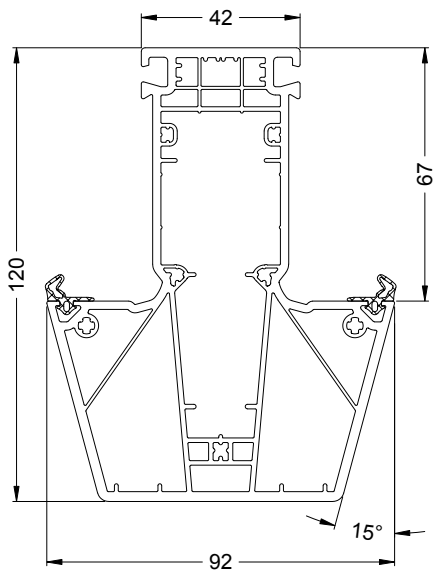

Art.-Nr.	I_x	I_y	t	L
20272900	3.73	2.34	1.5 mm	6 m
20273000	5.65	3.13	2 mm	6 m
20273100	6.6	3.66	2.5 mm	6 m
20285900	5.65	3.47	2.5 mm	6 m
20285700	6.44	3.92	3 mm	6 m
20129200	20.99	1.73	1.5 mm	6 m
20129300	32.79	2.5	2.5 mm	6 m
20274700	2.53	1.07	2 mm	6 m
20286700	2.92	1	2 mm	6 m

Art.-Nr. Art. No.	Abbildung Illustration	Benennung Description			
25254600		Reparaturdichtung: Anschlag- und Glasanlagedichtung Repair gasket: rebate gasket and glazing rebate gasket	schwarz Black	100 m*	EPDM-Dichtung, polymerisiert, nicht schweißbar EPDM gasket, polymerised, cannot be welded
25254500			silbergrau Silver grey		
25282000		Reparaturdichtung: Anschlag- und Glasanlagedichtung Repair gasket: rebate gasket and glazing rebate gasket	schwarz Black	100 m*	EPDM-Dichtung, nicht polymerisiert, schweißbar EPDM gasket, not polymerised, weldable
25281900			silbergrau Silver grey		
25094900		Klotzbrücke Glazing bridge	braun Brown	250 Stk.	Tragklotz für 3 mm Falztiefe Support block for 3 mm rebate depth
25094800		Klotzbrücke Glazing bridge	violett Violet	250 Stk.	Distanzklotz für 3 mm Falztiefe Spacer block for 3 mm rebate depth
25279400		Rahmenverbinder Frame connector	Silberfarbig Silver	20 Stk.	Rahmenverbinder für 3 mm Falztiefe Frame connector for 3 mm rebate depth
25278900		Falzverbinder Rebate connector	Silberfarbig Silver	20 Stk.	Falzverbinder für 3 mm Falztiefe Rebate connector for 3 mm rebate depth
25279000		Adapter Adapter	Silberfarbig Silver	20 Stk.	Adapter für Verbinder LivIng Variant Adapter for LivIng Variant connector
25240100		Bohrlehre Drilling jig	—	1 Stk.	Bohrlehre zum Vorbohren der Verschraubungsbohrungen in den Profalfalz der Blendrahmen bzw. Rahmenprofile. Drilling jig for pre-drilling the screw holes in the profile rebate of the outer frames and/or frame profiles.
25871100		Adapter Bohrlehre Adapter drilling jig	—	1 Stk.	Adapter für Bohrlehre T-Verbinder Adapter for drilling jig T-Profile connector
25282300		Dichtkissen Joint sealing piece	weiß White	100 Stk.	Zur Abdichtung der Profilvorkammern For sealing profile front chambers

T-Profil 120/92 Variant 6° ■ Variant T-profile 120/92, 6°
19469...

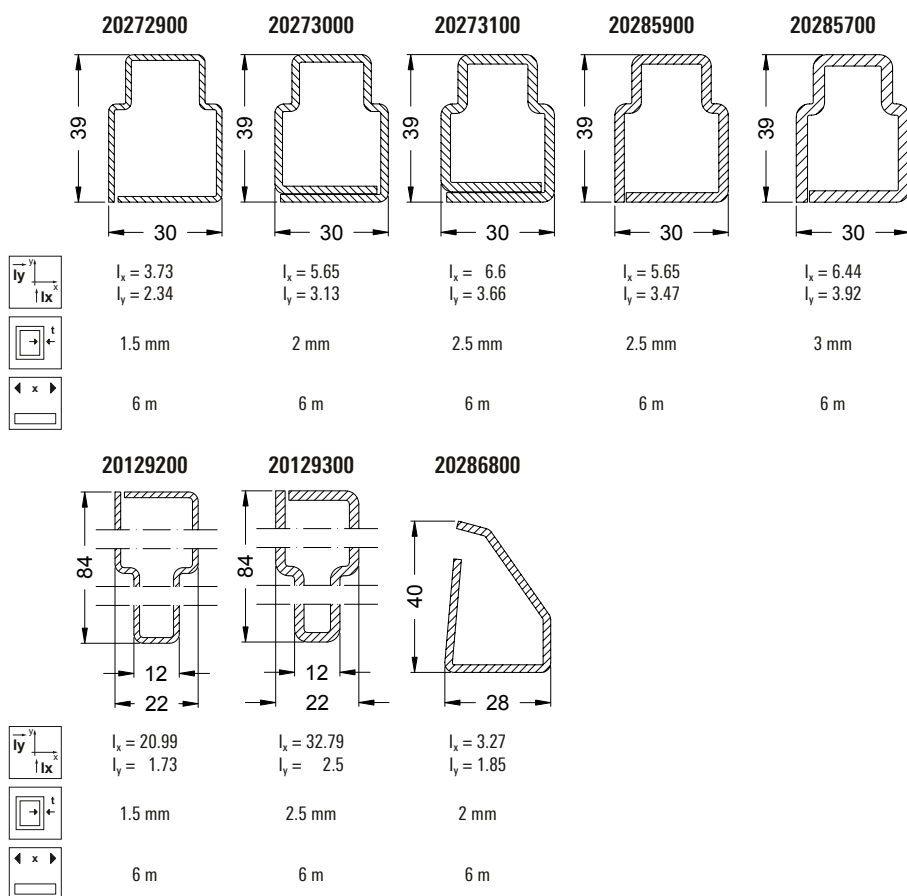
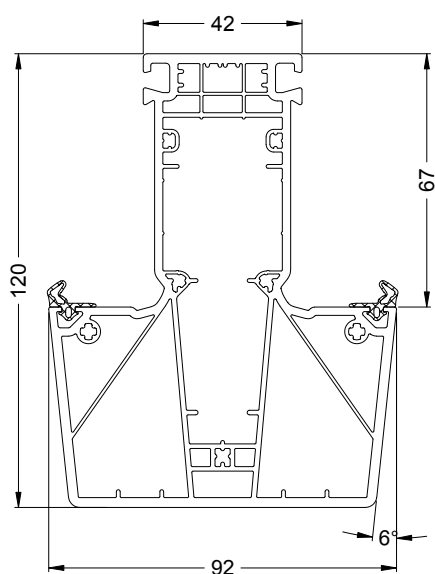

Art.-Nr. Art. No.	Abbildung Illustration	Benennung Description			
25254600		Reparaturdichtung: Anschlag- und Glasanlagedichtung Repair gasket: rebate gasket and glazing rebate gasket	schwarz Black	100 m*	EPDM-Dichtung, polymerisiert, nicht schweißbar EPDM gasket, polymerised, cannot be welded
25254500		Reparaturdichtung: Anschlag- und Glasanlagedichtung Repair gasket: rebate gasket and glazing rebate gasket	silbergrau Silver grey		
25282000		Reparaturdichtung: Anschlag- und Glasanlagedichtung Repair gasket: rebate gasket and glazing rebate gasket	schwarz Black	100 m*	EPDM-Dichtung, nicht polymerisiert, schweißbar EPDM gasket, not polymerised, weldable
25281900		Reparaturdichtung: Anschlag- und Glasanlagedichtung Repair gasket: rebate gasket and glazing rebate gasket	silbergrau Silver grey		
25094900		Klotzbrücke Glazing bridge	braun Brown	250 Stk.	Tragklotz für 3 mm Falztiefe Support block for 3 mm rebate depth
25094800		Klotzbrücke Glazing bridge	violett Violet	250 Stk.	Distanzklotz für 3 mm Falztiefe Spacer block for 3 mm rebate depth
25279400		Rahmenverbinder Frame connector	Silberfarbig Silver	20 Stk.	Rahmenverbinder für 3 mm Falztiefe Frame connector for 3 mm rebate depth
25278900		Falzverbinder Rebate connector	Silberfarbig Silver	20 Stk.	Falzverbinder für 3 mm Falztiefe Rebate connector for 3 mm rebate depth
25279000		Adapter Adapter	Silberfarbig Silver	20 Stk.	Adapter für Verbinder LivIng Variant Adapter for LivIng Variant connector
25240100		Bohrlehre Drilling jig	—	1 Stk.	Bohrlehre zum Vorbohren der Verschraubungsbohrungen in den Profalfalz der Blendrahmen bzw. Rahmenprofile. Drilling jig for pre-drilling the screw holes in the profile rebate of the outer frames and/or frame profiles.
25874900		Adapter Bohrlehre Adapter drilling jig	—	1 Stk.	Adapter für Bohrlehre T-Verbinder Adapter for drilling jig T-Profile connector
25282400		Dichtkissen Joint sealing piece	weiß White	100 Stk.	Zur Abdichtung der Profilverkammern For sealing profile front chambers

Flügelprosse 82/72 ■ Vent sash bar 82/72
19460...

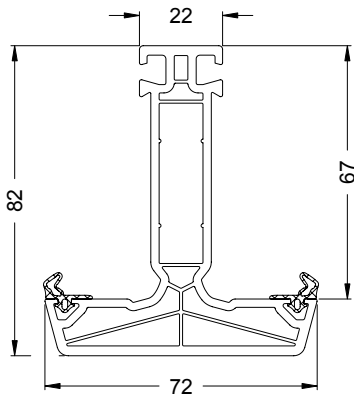

20272800

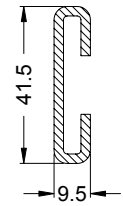

$l_x = 3.38$
 $l_y = 0.2$



2.5 mm



6 m

Art.-Nr. Art. No.	Abbildung Illustration	Benennung Description			
25254600		Reparaturdichtung: Anschlag- und Glasanlagendichtung Repair gasket: rebate gasket and glazing rebate gasket	schwarz Black	100 m*	EPDM-Dichtung, polymerisiert, nicht schweißbar EPDM gasket, polymerised, cannot be welded
25254500			silbergrau Silver grey		
25282000		Reparaturdichtung: Anschlag- und Glasanlagendichtung Repair gasket: rebate gasket and glazing rebate gasket	schwarz Black	100 m*	EPDM-Dichtung, nicht polymerisiert, schweißbar EPDM gasket, not polymerised, weldable
25281900			silbergrau Silver grey		
25094900		Klotzbrücke Glazing bridge	braun Brown	250 Stk.	Tragklotz für 3 mm Falztiefe Support block for 3 mm rebate depth
25094800		Klotzbrücke Glazing bridge	violett Violet	250 Stk.	Distanzklotz für 3 mm Falztiefe Spacer block for 3 mm rebate depth
25094500		Sprossenverbinder Sash bar connector	Silberfarbig Silver	20 Stk.	Sprossenverbinder für 3 mm Falztiefe Sash bar connectors for 3 mm rebate depth
25240200		Bohrlehre Drilling jig	—	1 Stk.	Bohrlehre zum Vorbohren der Verschraubungsbohrungen in den Profalfalz der Blendrahmen bzw. Rahmenprofile. Drilling jig for pre-drilling the screw holes in the profile rebate of the outer frames and/or frame profiles.
25094600		KS-Verbinder Plastic connector	grau Grey	20 Stk.	—

T-Profil 82/92 AS ■ T-profile 82/92 AS
19461...

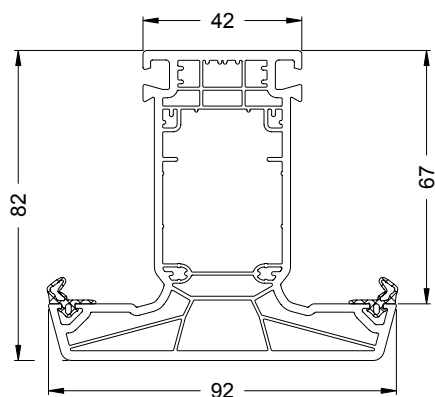

	20272900	20273000	20273100	20285900	20285700
$I_x = 3.73$ $I_y = 2.34$	$I_x = 5.65$ $I_y = 3.13$	$I_x = 6.6$ $I_y = 3.66$	$I_x = 5.65$ $I_y = 3.47$	$I_x = 6.44$ $I_y = 3.92$	
1.5 mm	2 mm	2.5 mm	2.5 mm	3 mm	
6 m	6 m	6 m	6 m	6 m	

	20271700	20271800
$I_x = 2.01$ $I_y = 1.6$	$I_x = 2.94$ $I_y = 2.33$	
1.5 mm	2.5 mm	
6 m	6 m	

Art.-Nr. Art. No.	Abbildung Illustration	Benennung Description			
25254600		Reparaturdichtung: Anschlag- und Glasanlagendichtung Repair gasket: rebate gasket and glazing rebate gasket	schwarz Black	100 m*	EPDM-Dichtung, polymerisiert, nicht schweißbar EPDM gasket, polymerised, cannot be welded
25254500		Reparaturdichtung: Anschlag- und Glasanlagendichtung Repair gasket: rebate gasket and glazing rebate gasket	silbergrau Silver grey		
25282000		Reparaturdichtung: Anschlag- und Glasanlagendichtung Repair gasket: rebate gasket and glazing rebate gasket	schwarz Black	100 m*	EPDM-Dichtung, nicht polymerisiert, schweißbar EPDM gasket, not polymerised, weldable
25281900		Reparaturdichtung: Anschlag- und Glasanlagendichtung Repair gasket: rebate gasket and glazing rebate gasket	silbergrau Silver grey		
25094900		Klotzbrücke Glazing bridge	braun Brown	250 Stk.	Tragklotz für 3 mm Falztiefe Support block for 3 mm rebate depth
25094800		Klotzbrücke Glazing bridge	violett Violet	250 Stk.	Distanzklotz für 3 mm Falztiefe Spacer block for 3 mm rebate depth
25090700		Rahmenverbinder Frame connector	schwarz Black	20 Stk.	Rahmenverbinder für 3 mm Falztiefe Frame connector for 3 mm rebate depth
25090500		Rahmenverbinder Frame connector	Silberfarbig Silver		
25090800		Falzverbinder Rebate connector	schwarz Black	20 Stk.	Falzverbinder für 3 mm Falztiefe Rebate connector for 3 mm rebate depth
25090600		Falzverbinder Rebate connector	Silberfarbig Silver		
25240100		Bohrlehre Drilling jig	—	1 Stk.	Bohrlehre zum Vorbohren der Verschraubungsbohrungen in den Profilfalz der Blendrahmen bzw. Rahmenprofile. Drilling jig for pre-drilling the screw holes in the profile rebate of the outer frames and/or frame profiles.
25090900		KS-Türschwellenverbinder 92 Plastic door threshold connector 92	grau Grey	20 Stk.	zum Einschieben in das gefräßte T-Profil For inserting into the machined T-profile

T-Profil 82/112 AS ■ T-profile 82/112 AS

19462...

19463160 Lieferlänge: 6,5 m ■ Stock length: 6.5 m

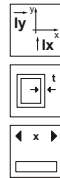
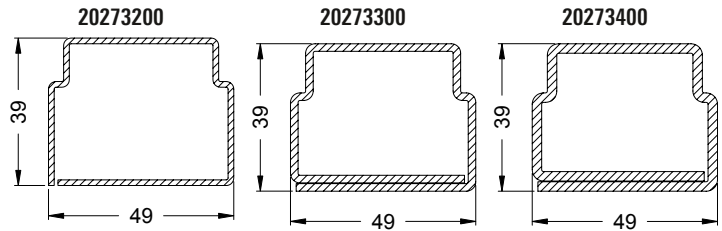
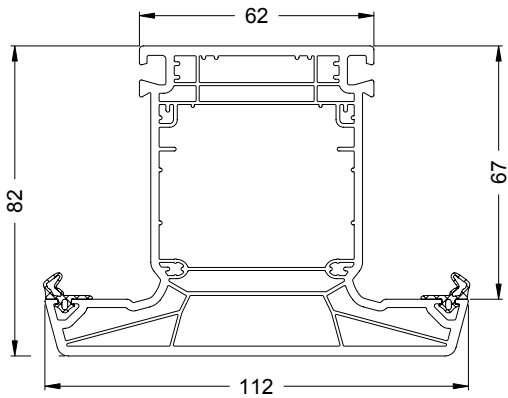

$I_x = 5.79$
 $I_y = 8.01$

1.5 mm

6 m

$I_x = 9.05$
 $I_y = 11.5$

2 mm

6 m

$I_x = 10.68$
 $I_y = 13.71$

2.5 mm

6 m

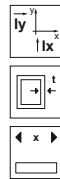
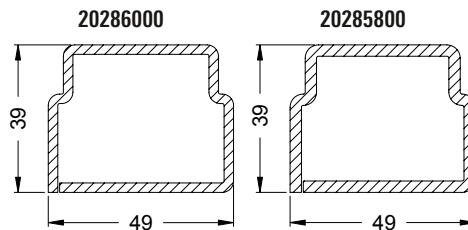

$I_x = 8.91$
 $I_y = 12.34$

2.5 mm

6 m

$I_x = 10.25$
 $I_y = 14.18$

3 mm

6 m

Art.-Nr. Art. No.	Abbildung Illustration	Benennung Description			
25254600		Reparaturdichtung: Anschlag- und Glasanlagendichtung Repair gasket: rebate gasket and glazing rebate gasket	schwarz Black	100 m*	EPDM-Dichtung, polymerisiert, nicht schweißbar EPDM gasket, polymerised, cannot be welded
25254500		Reparaturdichtung: Anschlag- und Glasanlagendichtung Repair gasket: rebate gasket and glazing rebate gasket	silbergrau Silver grey		
25282000		Reparaturdichtung: Anschlag- und Glasanlagendichtung Repair gasket: rebate gasket and glazing rebate gasket	schwarz Black	100 m*	EPDM-Dichtung, nicht polymerisiert, schweißbar EPDM gasket, not polymerised, weldable
25281900		Reparaturdichtung: Anschlag- und Glasanlagendichtung Repair gasket: rebate gasket and glazing rebate gasket	silbergrau Silver grey		
25094900		Klotzbrücke Glazing bridge	braun Brown	250 Stk.	Tragklotz für 3 mm Falztiefe Support block for 3 mm rebate depth
25094800		Klotzbrücke Glazing bridge	violett Violet	250 Stk.	Distanzklotz für 3 mm Falztiefe Spacer block for 3 mm rebate depth
25091200		Rahmenverbinder Frame connector	schwarz Black	20 Stk.	Rahmenverbinder für 3 mm Falztiefe Frame connector for 3 mm rebate depth
25091000		Rahmenverbinder Frame connector	Silberfarbig Silver		
25091300		Falzverbinder Rebate connector	schwarz Black	20 Stk.	Falzverbinder für 3 mm Falztiefe Rebate connector for 3 mm rebate depth
25091100		Falzverbinder Rebate connector	Silberfarbig Silver		
25240100		Bohrlehre Drilling jig	—	1 Stk.	Bohrlehre zum Vorbohren der Verschraubungsbohrungen in den Profalfalz der Blendrahmen bzw. Rahmenprofile. Drilling jig for pre-drilling the screw holes in the profile rebate of the outer frames and/or frame profiles.
25091400		KS-Türschwellenverbinder 112 Plastic door threshold connector 112	grau Grey	20 Stk.	zum Einschieben in das gefräste T-Profil For inserting into the machined T-profile

Wechselprofile

Reverse rebate profiles

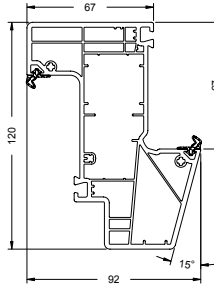
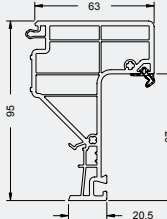
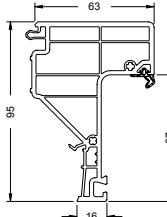
Art.-Nr. Art. No.	Abbildung Illustration	Benennung Description	
19487...		Wechselprofil 120/92 Variant 15° Variant reverse rebate profile 120/92, 15°	68
19498...		Adapter-Wechselprofil 95/63 Variant 15° Variant adapter reverse rebate profile 95/63, 15°	69
19499...		Adapter-Wechselprofil 95/63 Variant 6° Variant adapter reverse rebate profile 95/63, 6°	70

Wechselprofil 120/92 Variant 15°
Variant reverse rebate profile 120/92, 15°



19487...

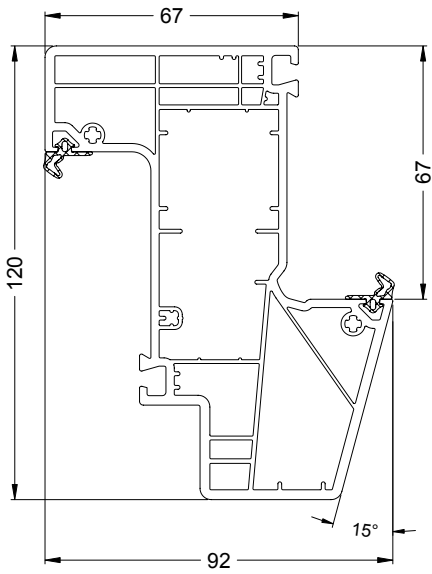

20271700

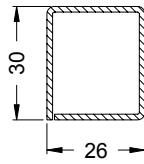

$I_x = 2.01$
 $I_y = 1.6$

1.5 mm

6 m

20271800

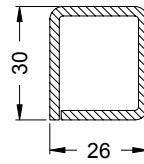

$I_x = 2.94$
 $I_y = 2.33$

2.5 mm

6 m

20274700

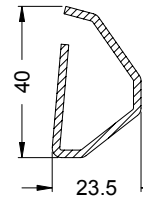

$I_x = 2.53$
 $I_y = 1.07$

2 mm

6 m

20286700

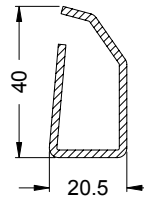

$I_x = 2.92$
 $I_y = 1$

2 mm

6 m

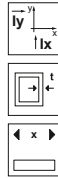

20274500

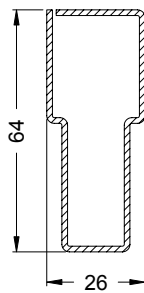

$I_x = 11.68$
 $I_y = 2.27$

1.5 mm

6 m

20274600

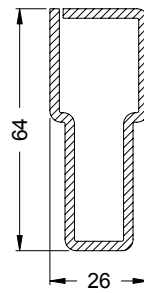

$I_x = 18.09$
 $I_y = 3.34$

2.5 mm

6 m

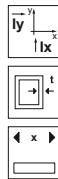

Art.-Nr. Art. No.	Abbildung Illustration	Benennung Description			
25254600		Reparaturdichtung: Anschlag- und Glasanlagedichtung Repair gasket: rebate gasket and glazing rebate gasket	schwarz Black	100 m*	EPDM-Dichtung, polymerisiert, nicht schweißbar EPDM gasket, polymerised, cannot be welded
25254500			silbergrau Silver grey		
25282000		Reparaturdichtung: Anschlag- und Glasanlagedichtung Repair gasket: rebate gasket and glazing rebate gasket	schwarz Black	100 m*	EPDM-Dichtung, nicht polymerisiert, schweißbar EPDM gasket, not polymerised, weldable
25281900			silbergrau Silver grey		
25094900		Klotzbrücke Glazing bridge	braun Brown	250 Stk.	Tragklotz für 3 mm Falztiefe Support block for 3 mm rebate depth
25094800		Klotzbrücke Glazing bridge	violett Violet	250 Stk.	Distanzklotz für 3 mm Falztiefe Spacer block for 3 mm rebate depth
24205900		Entwässerungskappe Drainage cover cap	weiß White	1000 Stk.	—
25261300		Fensterfalzlüfter Schüco VentoAir RF LivIng 82 AS Schüco VentoAir RF Living 82 AS window rebate fan	weiß White	20 Stk.	Set aus Trägerbauteil, Flügelsystemdichtung grau, Rückstellfeder Kit comprises bracket components, grey vent system gasket, release spring



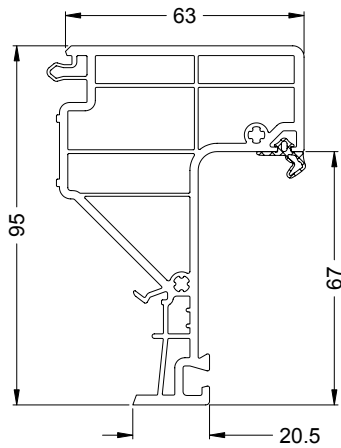

Adapter-Wechselprofil 95/63 Variant 15°
 Variant adapter reverse rebate profile 95/63, 15°

19498... Lieferlänge: 6,5 m ■ Stock length: 6.5 m

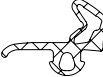
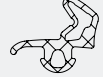

Profile
Profiles

Art.-Nr. Art. No.	Abbildung Illustration	Benennung Description			
25254600		Reparaturdichtung: Anschlag- und Glasanlagedichtung Repair gasket: rebate gasket and glazing rebate gasket	schwarz Black	100 m*	EPDM-Dichtung, polymerisiert, nicht schweißbar EPDM gasket, polymerised, cannot be welded
25254500			silbergrau Silver grey		
25282000		Reparaturdichtung: Anschlag- und Glasanlagedichtung Repair gasket: rebate gasket and glazing rebate gasket	schwarz Black	100 m*	EPDM-Dichtung, nicht polymerisiert, schweißbar EPDM gasket, not polymerised, weldable
25281900			silbergrau Silver grey		





Adapter-Wechselprofil 95/63 Variant 6°
Variant adapter reverse rebate profile 95/63, 6°

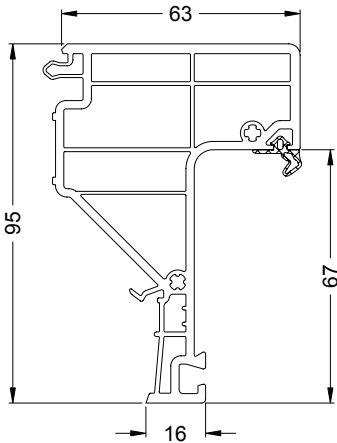

19499... Lieferlänge: 6,5 m ■ Stock length: 6.5 m

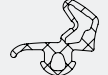

Profile
Profiles

Art.-Nr. Art. No.	Abbildung Illustration	Benennung Description			
25254600		Reparaturdichtung: Anschlag- und Glasanlagendichtung Repair gasket: rebate gasket and glazing rebate gasket	schwarz Black	100 m*	EPDM-Dichtung, polymerisiert, nicht schweißbar EPDM gasket, polymerised, cannot be welded
25254500			silbergrau Silver grey		
25282000		Reparaturdichtung: Anschlag- und Glasanlagendichtung Repair gasket: rebate gasket and glazing rebate gasket	schwarz Black	100 m*	EPDM-Dichtung, nicht polymerisiert, schweißbar EPDM gasket, not polymerised, weldable
25281900			silbergrau Silver grey		

Stulpprofile

Meeting stile profiles

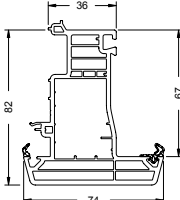
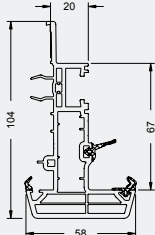
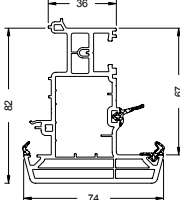
Art.-Nr. Art. No.	Abbildung Illustration	Benennung Description		
19473...		Stulpprofil 74 AS Double-vent profile 74 AS	AS	72
19471...		Stulpprofil 58 MD Double-vent profile 58 MD	AS MD	73
19472...		Stulpprofil 74 MD Double-vent profile 74 MD	AS MD	74

Stulprofil 74 AS ■ Double-vent profile 74 AS
19473...

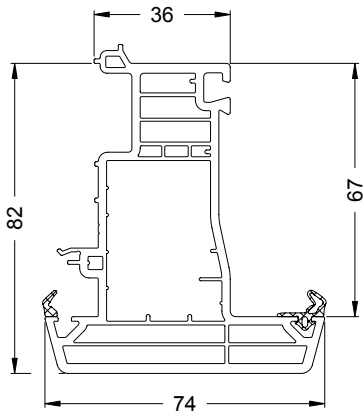

	20271700	20271800	20273700	20273800
$I_x = 2.01$ $I_y = 1.6$	$I_x = 2.94$ $I_y = 2.33$	$I_x = 4.58$ $I_y = 1.92$	$I_x = 6.01$ $I_y = 2.43$	
1.5 mm	2.5 mm	1.5 mm	2 mm	
6 m	6 m	6 m	6 m	

Art.-Nr. Art. No.	Abbildung Illustration	Benennung Description			
25254600		Reparaturdichtung: Anschlag- und Glasanlagendichtung Repair gasket: rebate gasket and glazing rebate gasket	schwarz Black	100 m*	EPDM-Dichtung, polymerisiert, nicht schweißbar EPDM gasket, polymerised, cannot be welded
25254500		silbergrau Silver grey			
25282000		Reparaturdichtung: Anschlag- und Glasanlagendichtung Repair gasket: rebate gasket and glazing rebate gasket	schwarz Black	100 m*	EPDM-Dichtung, nicht polymerisiert, schweißbar EPDM gasket, not polymerised, weldable
25281900		silbergrau Silver grey			
25235500		Stulpendstück (Grundkörper) Double-vent end piece (base profile)	weiß White	10 P.	—
25235600			schwarz Black		
25235700			cremeweiß Cream white		
25235900			karamell Caramel		
25259200			dunkelgrau Dark grey		
25096000		Stulpendstück (Außenteil 15°) Double-vent end piece (outside section 15°)	weiß White	10 P.	—
25096100			schwarz Black		
25096200			cremeweiß Cream white		
25096400			karamell Caramel		
25258500			dunkelgrau Dark grey		
25098200		Stulpendstück (Außenteil Schwelle) Double-vent end piece (outside section for threshold)	weiß White	5 Stk.	rechts Right
25098300			links Left		
25098400			rechts Right		
25098500			links Left		
25099100			rechts Right		
25099300			links Left		
25098600			rechts Right		
25098700			links Left		
25258600			rechts Right		
25258700			links Left		

Stulpprofil 58 MD ■ Double-vent profile 58 MD
19471...

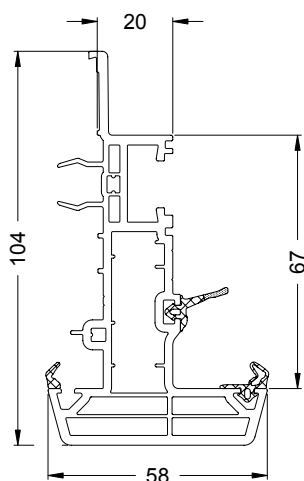

20273600 20272800

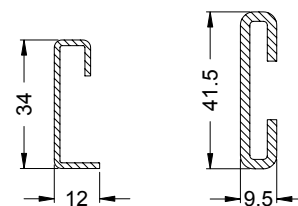

$I_x = 1.32$
 $I_y = 0.11$

$I_x = 3.38$
 $I_y = 0.2$



1.5 mm

2.5 mm



6 m

6 m

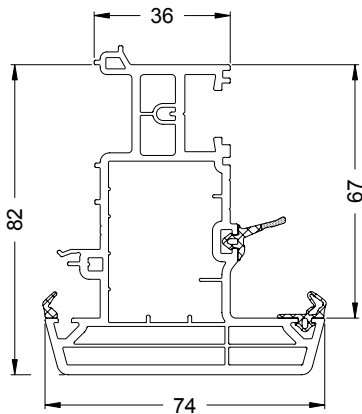

Art.-Nr. Art. No.	Abbildung Illustration	Benennung Description			
25254000		Reparaturdichtung: Mitteldichtung Repair gasket: centre gasket	schwarz Black	100 m*	EPDM-Dichtung, polymerisiert, nicht schweißbar EPDM gasket, polymerised, cannot be welded
25253900		silbergrau Silver grey			
25254600		Reparaturdichtung: Anschlag- und Glasanlagedichtung Repair gasket: rebate gasket and glazing rebate gasket	schwarz Black	100 m*	EPDM-Dichtung, polymerisiert, nicht schweißbar EPDM gasket, polymerised, cannot be welded
25254500		silbergrau Silver grey			
25282000		Reparaturdichtung: Anschlag- und Glasanlagedichtung Repair gasket: rebate gasket and glazing rebate gasket	schwarz Black	100 m*	EPDM-Dichtung, nicht polymerisiert, schweißbar EPDM gasket, not polymerised, weldable
25281900		silbergrau Silver grey			
25096500		Stulpendstück, einteilig Double-vent end piece, one-piece	weiß White	100 P.	—
25096700		schwarz Black			
25096800		Stulpendstück (Grundkörper) Double-vent end piece (base profile)	weiß White	10 P.	—
25096900			weiß White		
25097000			schwarz Black		
25097200			karamell Caramel		
25258800			dunkelgrau Dark grey		
25097300		Stulpendstück (Außenteil 15°) Double-vent end piece (outside section 15°)	weiß White	10 P.	—
25097400			schwarz Black		
25097600			karamell Caramel		
25258900			dunkelgrau Dark grey		
25236500		Stulpendstück (Außenteil Schwelle) Double-vent end piece (outside section for threshold)	weiß White	5 Stk.	rechts Right
25236600			schwarz Black		links Left
25236700			schwarz Black		rechts Right
25236800			schwarz Black		links Left
25236900			karamell Caramel		rechts Right
25237000			karamell Caramel		links Left
25259000			dunkelgrau Dark grey		rechts Right
25259100			dunkelgrau Dark grey		links Left

Stulprofil 74 MD ■ Double-vent profile 74 MD
19472...



	20271500	20271700	20271800	20273700
$I_x = 1.35$ $I_y = 0.72$	$I_x = 2.01$ $I_y = 1.6$	$I_x = 2.94$ $I_y = 2.33$	$I_x = 4.58$ $I_y = 1.92$	
1.5 mm	1.5 mm	2.5 mm	1.5 mm	
6 m	6 m	6 m	6 m	

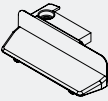
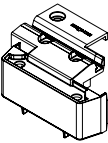

Art.-Nr. Art. No.	Abbildung Illustration	Benennung Description			
25254000		Reparaturdichtung: Mitteldichtung Repair gasket: centre gasket	schwarz Black	100 m*	EPDM-Dichtung, polymerisiert, nicht schweißbar EPDM gasket, polymerised, cannot be welded
25253900		silbergrau Silver grey			
25254600		Reparaturdichtung: Anschlag- und Glasanlagendichtung Repair gasket: rebate gasket and glazing rebate gasket	schwarz Black	100 m*	EPDM-Dichtung, polymerisiert, nicht schweißbar EPDM gasket, polymerised, cannot be welded
25254500		silbergrau Silver grey			
25282000		Reparaturdichtung: Anschlag- und Glasanlagendichtung Repair gasket: rebate gasket and glazing rebate gasket	schwarz Black	100 m*	EPDM-Dichtung, nicht polymerisiert, schweißbar EPDM gasket, not polymerised, weldable
25281900		silbergrau Silver grey			
25095000		Stulpendstück, einteilig Double-vent end piece, one-piece	weiß White	100 P.	—
25095200			schwarz Black		
25095300			weiß White		
25095400			weiß White		
25095500			schwarz Black		
25095600			cremeweiß Cream white		
25095700			cremeweiß Cream white		
25095900			karamell Caramel		
25258400			dunkelgrau Dark grey		



Art.-Nr. Art. No.	Abbildung Illustration	Benennung Description			
25096000		Stulpendstück (Außenteil 15°) Double-vent end piece (outside section 15°)	weiß White	10 P.	—
25096100			schwarz Black		
25096200			cremeweiß Cream white		
25096400			karamell Caramel		
25258500			dunkelgrau Dark grey		
25098200		Stulpendstück (Außenteil Schwelle) Double-vent end piece (outside section for threshold)	weiß White	5 Stk.	rechts Right
25098300			schwarz Black		links Left
25098400					rechts Right
25098500			links Left		
25099100			cremeweiß Cream white		rechts Right
25099300					links Left
25098600			karamell Caramel		rechts Right
25098700					links Left
25258600			dunkelgrau Dark grey		rechts Right
25258700					links Left

Flachleisten und Winkelprofile für Schüco LivIng Variant (mit Nut)

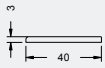
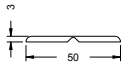
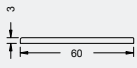
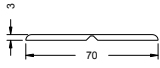
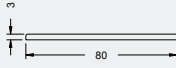
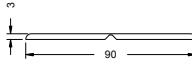
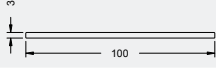
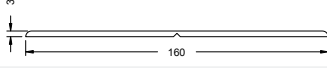
Flat bar and angled profiles for Schüco LivIng Variant (with groove)

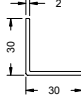
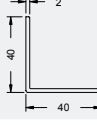
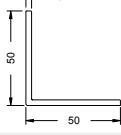
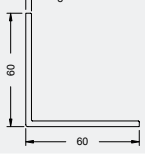
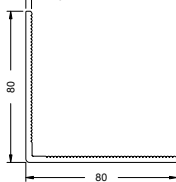
Profile
Profiles

Art.-Nr. Art. No.	Abbildung Illustration	Benennung Description	
17775...		Flachprofil 40/3 Flat profile 40/3	6,0 m
17283...		Flachprofil 50/3 Flat profile 50/3	6,0 m
18785...		Flachprofil 60/3 Flat profile 60/3	6,0 m
18786...		Flachprofil 70/3 Flat profile 70/3	6,0 m
18787...		Flachprofil 80/3 Flat profile 80/3	6,0 m
18788...		Flachprofil 90/3 Flat profile 90/3	6,0 m
17165...		Flachprofil 100/3 Flat profile 100/3	6,0 m
17172...		Flachprofil 160/3 Flat profile 160/3	6,0 m
18781...		Winkelprofil 20/20/2,5 Angled profile 20/20/2,5	6,0 m
18782...		Winkelprofil 30/30/2 Angled profile 30/30/2	6,0 m
18783...		Winkelprofil 40/40/2 Angled profile 40/40/2	6,0 m
17170...		Winkelprofil 50/50/3 Angled profile 50/50/3	6,0 m
18784...		Winkelprofil 60/60/3 Angled profile 60/60/3	6,0 m
18475...		Winkelprofil 80/80/3 Angled profile 80/80/3	6,0 m

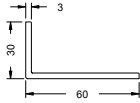
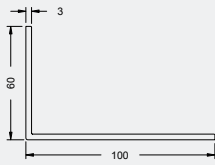
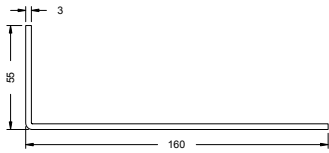
Art.-Nr. Art. No.	Abbildung Illustration	Benennung Description	
18397...		Winkelprofil 30/15/3 Angled profile 30/15/3	6,0 m
18398...		Winkelprofil 60/30/3 Angled profile 60/30/3	6,0 m
18399...		Winkelprofil 100/60/3 Angled profile 100/60/3	6,0 m
18010...		Winkelprofil 160/55/3 Angled profile 160/55/3	6,0 m

Anschlussmöglichkeiten
Attachment options

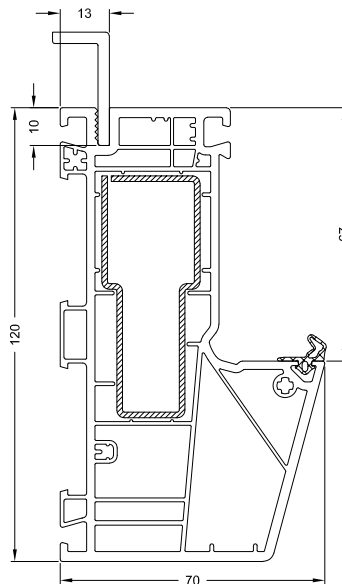
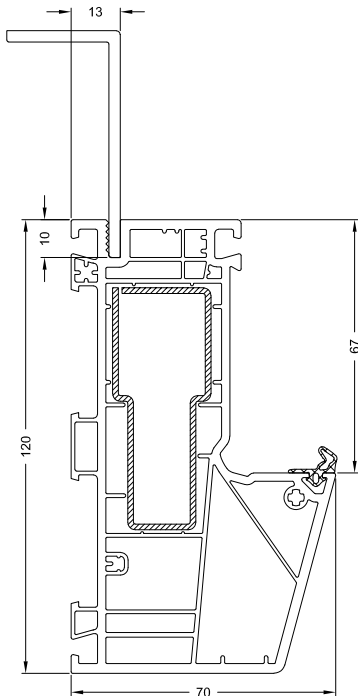

Schüco Liv**Ing** Variant — Zubehör
Schüco Liv**Ing** Variant — Accessories

Zubehör
Accessories

79

- 80 Glasleisten Schüco LivIng
Glazing beads for Schüco LivIng
- 84 Austauschdichtungen für Glasleisten
Replacement gaskets for glazing beads
- 85 Verglasungsklötze
Glazing blocks
- 86 Ziersprossen
Decorative sash bars
- 87 Maschinenzubehör
Machine accessories
- 87 Schrauben für Stahlverschraubung
Screws for steel screw connections

Glasleisten Schüco LivIng

Glazing beads for Schüco LivIng

Zubehör
Accessories

TA 05.2018

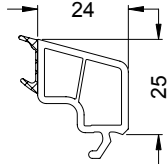
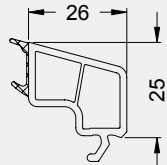
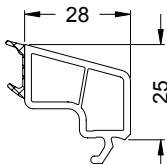
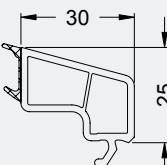
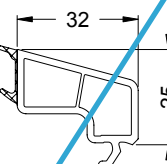
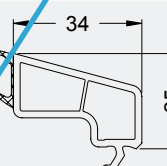
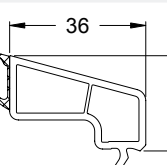

Art.-Nr. Art. No.	Abbildung Illustration	Benennung Description	
19550...		Glasleiste 8/25 Glazing bead 8/25	52 mm
19551...		Glasleiste 10/25 Glazing bead 10/25	50 mm
19552...		Glasleiste 12/25 Glazing bead 12/25	48 mm
19553...		Glasleiste 14/25 Glazing bead 14/25	46 mm
19554...		Glasleiste 16/25 Glazing bead 16/25	44 mm
19555...		Glasleiste 18/25 Glazing bead 18/25	42 mm
19556...		Glasleiste 20/25 Glazing bead 20/25	40 mm
19557...		Glasleiste 22/25 Glazing bead 22/25	38 mm

TA 05.2018

Art.-Nr. Art. No.	Abbildung Illustration	Benennung Description	
19558...		Glasleiste 24/25 Glazing bead 24/25	36 mm
19559...		Glasleiste 26/25 Glazing bead 26/25	34 mm
19560...		Glasleiste 28/25 Glazing bead 28/25	32 mm
19561...		Glasleiste 30/25 Glazing bead 30/25	30 mm
19562...		Glasleiste 32/25 Glazing bead 32/25	28 mm
19563...		Glasleiste 34/25 Glazing bead 34/25	26 mm
19564...		Glasleiste 36/25 Glazing bead 36/25	24 mm

Design Glasleisten Schüco LivIng Feature glazing beads for Schüco LivIng

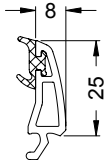
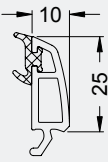
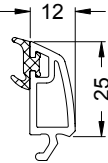
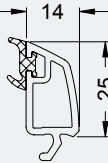
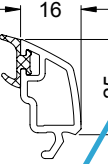
TA 05.2018

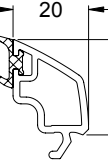
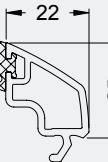
Art.-Nr. Art. No.	Abbildung Illustration	Benennung Description	
19580...		Glasleiste 8/25 Glazing bead 8/25	52 mm
19581...		Glasleiste 10/25 Glazing bead 10/25	50 mm
19582...		Glasleiste 12/25 Glazing bead 12/25	48 mm
19583...		Glasleiste 14/25 Glazing bead 14/25	46 mm
19584...		Glasleiste 16/25 Glazing bead 16/25	44 mm
19585...		Glasleiste 18/25 Glazing bead 18/25	42 mm
19586...		Glasleiste 20/25 Glazing bead 20/25	40 mm
19587...		Glasleiste 22/25 Glazing bead 22/25	38 mm

TA 05.2018

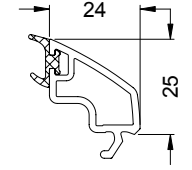
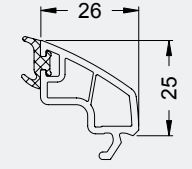
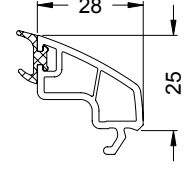
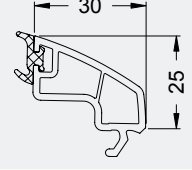
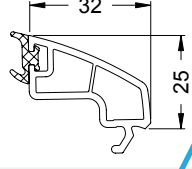
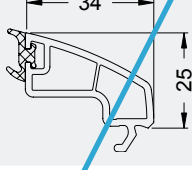
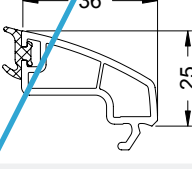
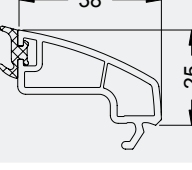
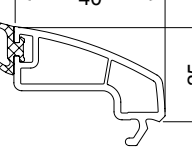







Art.-Nr. Art. No.	Abbildung Illustration	Benennung Description	
19588...		Glasleiste 24/25 Glazing bead 24/25	36 mm
19589...		Glasleiste 26/25 Glazing bead 26/25	34 mm
19590...		Glasleiste 28/25 Glazing bead 28/25	32 mm
19591...		Glasleiste 30/25 Glazing bead 30/25	30 mm
19592...		Glasleiste 32/25 Glazing bead 32/25	28 mm
19593...		Glasleiste 34/25 Glazing bead 34/25	26 mm
19594...		Glasleiste 36/25 Glazing bead 36/25	24 mm
19595...		Glasleiste 38/25 Glazing bead 38/25	22 mm
19596...		Glasleiste 40/25 Glazing bead 40/25	20 mm

Austauschdichtungen für Glasleisten

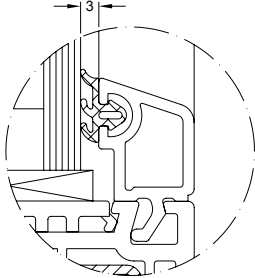
Replacement gaskets for glazing beads

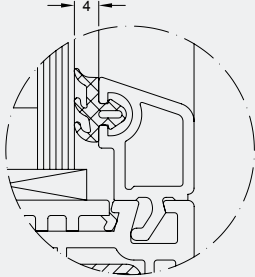
Mit Hilfe der Austauschdichtungen können die werkseitig angebrachten Glasleistendichtungen manuell ausgetauscht werden, wenn ein größeres Spaltmaß vorliegt oder Toleranzen ausgeglichen werden müssen.

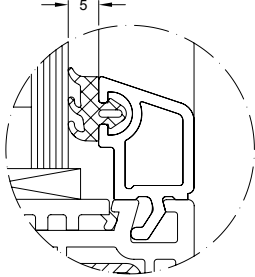
Using the replacement gaskets, the glazing bead gaskets fitted in the workshop can be manually replaced if there is a larger gap dimension or tolerances need to be compensated.

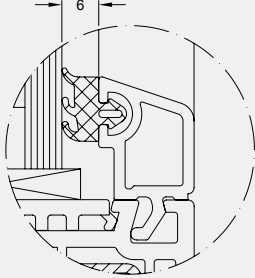
Art.-Nr. Art. No.		Abbildung Illustration	Spaltmaß Gap dimension		
22488800	100 m*			3 mm	Markierung: grün Marking: Green
22452400	200 m*				
22488900	100 m*			4 mm	Markierung: gelb Marking: Yellow
22452500	200 m*				
22492200	100 m*			5 mm	Markierung: blau Marking: Blue
22452600	200 m*				
22494400	100 m*			6 mm	Markierung: – Marking: –
22451000	200 m*				

Verglasungsklotze

Glazing blocks

Art.-Nr. Art. No.			Abbildung Illustration	Benennung Description	
25074000	rot ■ Red	2 mm		Verglasungsklotz 100x30 Glazing block 100 x 30	500 Stk.
25074100	grün ■ Green	3 mm			
25074200	gelb ■ Yellow	4 mm			
25074300	blau ■ Blue	5 mm			
25074400	schwarz ■ Black	6 mm		Verglasungsklotz 100x40 Glazing block 100 x 40	500 Stk.
25074500	rot ■ Red	2 mm			
25074600	grün ■ Green	3 mm			
25074700	gelb ■ Yellow	4 mm			
25074800	blau ■ Blue	5 mm		Verglasungsklotz 100x50 Glazing block 100 x 50	100 Stk.
25074900	schwarz ■ Black	6 mm			
25075000	rot ■ Red	2 mm			
25075100	grün ■ Green	3 mm			
25075200	gelb ■ Yellow	4 mm		Verglasungsklotz 100x54 Glazing block 100 x 54	100 Stk.
25075300	blau ■ Blue	5 mm			
25075400	schwarz ■ Black	6 mm			
25235000	rot ■ Red	2 mm			
25235100	grün ■ Green	3 mm		Verglasungsklotz 100x65 Glazing block 100 x 65	100 Stk.
25235200	gelb ■ Yellow	4 mm			
25235300	blau ■ Blue	5 mm			
25235400	schwarz ■ Black	6 mm			
25261600	rot ■ Red	2 mm			
25261700	grün ■ Green	3 mm			
25261800	gelb ■ Yellow	5 mm			

Ziersprossen

Decorative sash bars



Hinweis:
Es ist zu beachten, dass die Tiefe der Glasleiste größer als die Höhe der Ziersprosse sein muss.



Note:
Ensure that the depth of glazing bead is greater than the height of the decorative sash bar.

Art.-Nr. Art. No.		Abbildung Illustration	Benennung Description
19223...	-		Ziersprosse 9/27 Decorative sash bar 9/27
19181...	-		Ziersprosse 11/27 Decorative sash bar 11/27
19182...	-		Ziersprosse 13/27 Decorative sash bar 13/27
19183...	-		Ziersprosse 13/34 Decorative sash bar 13/34
19184...	-		Ziersprosse 13/45 Decorative sash bar 13/45
19185...	-		Ziersprosse 13/65 Decorative sash bar 13/65
19186...	-		Design-Ziersprosse 13/34 Feature decorative sash bar 13/34
13296000	roh ■ Mill finish		Alu-Ziersprosse 12/25 Aluminium decorative sash bar 12/25
13296010	weiß ■ White		
17101...	foliert ■ Foiled		
13296100	roh ■ Mill finish		Alu-Ziersprosse 12/36 Aluminium decorative sash bar 12/36
13296110	weiß ■ White		
17103...	foliert ■ Foiled		
13297700	roh ■ Mill finish		Alu-Ziersprosse 12/45 Aluminium decorative sash bar 12/45
13297710	weiß ■ White		
17116...	foliert ■ Foiled		

TA 09.2018

Maschinenzubehör

Machine accessories

Art.-Nr. Art. No.	Benennung Description			
28635000	Frärsatz Ziersprossen Milling tool set Decorative sash bars	1 Stk.	Graule AKF 6	Fräswelle Ø 40/ linksdrehend/ Ø-Außen 200 Milling shaft Ø 40 / turning to the left / Ø outside 200
28635100	Frärsatz Ziersprossen Milling tool set Decorative sash bars	1 Stk.	Rotox SAF 165/ 166/ 167	Fräswelle Ø 40/ rechtsdrehend/ Ø-Außen 140 Milling shaft Ø 40 / turning to the right / Ø outside 140



Hinweis:





Weitere Informationen zu Maschinen und deren Zubehör finden Sie im Katalog „Schüco Maschinen und Zubehör“. 79000

Note:

For more information on machines and their accessories, see the “Schüco machinery and accessories” manual. 79000

Schrauben für Stahlverschraubung

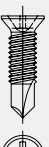
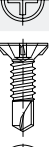
Screws for steel screw connections

Art.-Nr. Art. No.	Abbildung Illustration	Benennung Description		
20562600		Bohrschraube M4 x 13 (DIN 7962) Self-drilling screw M4 x 13 (DIN 7962)	Schraubenkopf $\varnothing = 6$ mm Screw head $\varnothing = 6$ mm	1000 Stk.
20551700		Bohrschraube M4 x 15 (DIN 7962) Self-drilling screw M4 x 15 (DIN 7962)	Schraubenkopf $\varnothing = 6$ mm Screw head $\varnothing = 6$ mm	1000 Stk.
20587000		Bohrschraube 3,7 x 13 Self-drilling screw 3.7 x 13	Schraubenkopf $\varnothing = 7$ mm Screw head $\varnothing = 7$ mm	8000 Stk.
20587100		Bohrschraube 3,7 x 15 Self-drilling screw 3.7 x 15	Schraubenkopf $\varnothing = 7$ mm Screw head $\varnothing = 7$ mm	7000 Stk.
20587200		Bohrschraube 3,7 x 22 Self-drilling screw 3.7 x 22	Schraubenkopf $\varnothing = 7$ mm Screw head $\varnothing = 7$ mm	6000 Stk.

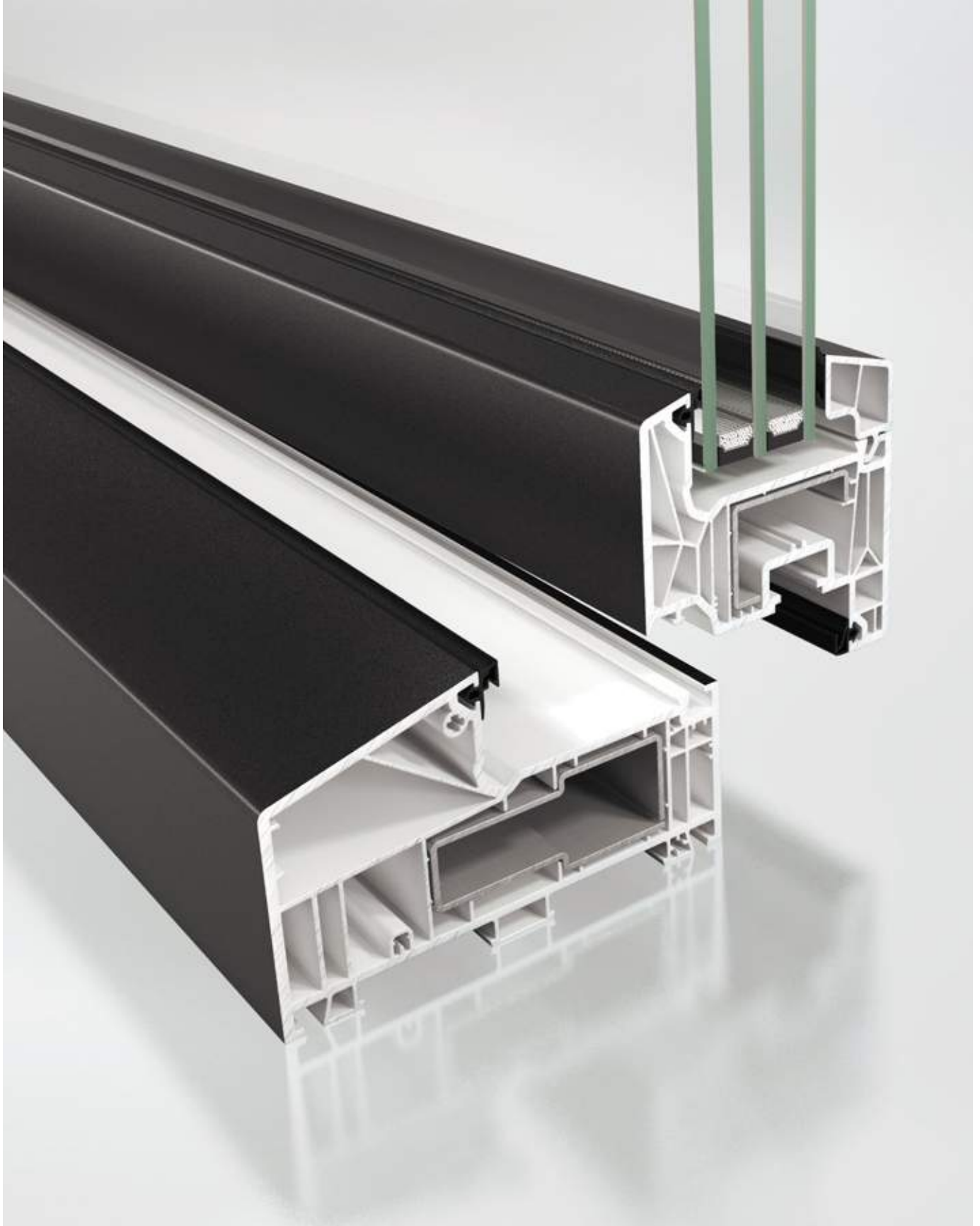

Foliensortiment
Foil range

Foliensortiment
Foil range

89

- 91 Foliensortiment Schüco **Living** Variant Folien Lieferzeit I
Range of foils for Schüco **Living** Variant Foil delivery time I
- 92 Foliensortiment Standard-Folien
Foil range Standard foils

Hinweis für folierte Elemente ■ Information about foiled units

Bitte beachten Sie die Profilauswahl für folierte Elemente. Das untere Blendrahmenprofil muss ein 15° Profil sein.

Please note the choice of profiles for foiled units. The bottom outer frame profile must be a 15° profile.

Foliert
Foiled

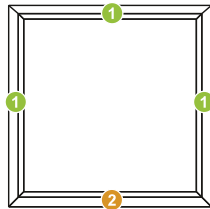

- 1 6°
- 2 15°

Unfoliert
Unfoiled

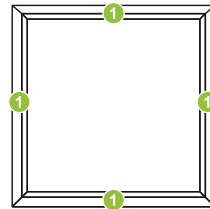

- 1 6°
- 1 6°

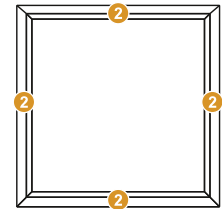





- 2 15°
- 2 15°

Foliensortiment Schüco Living Variant

Range of foils for Schüco Living Variant

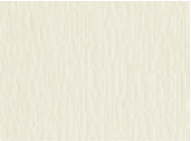











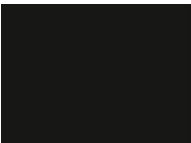











Folien Lieferzeit I ■ Foil delivery time I

	Farbbezeichnung Colour description	Farbkürzel Colour ID		
 456-5054	Cremeweiß, ähnlich RAL 9001 Cream white, similar to RAL 9001	CW	—	148 

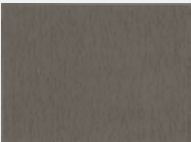



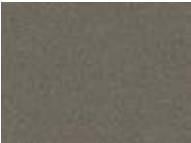







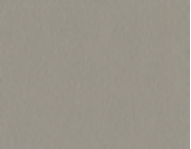

Foliensortiment

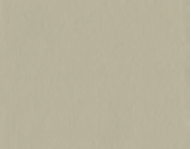









Foil range



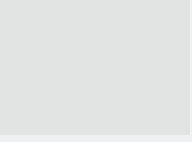
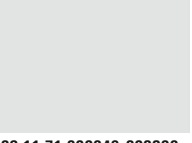









Standard-Folien ■ Standard foils

	Farbbezeichnung Colour description	Farbkürzel Colour ID			
 02.11.71.000042-808300 702105-083	Schwarzgrau, ähnlich RAL 7021 (glatt) Dark grey, similar to RAL 7021 (glossy)	SC	533	128	
 436-5003A	Anthrazitgrau, ähnlich RAL 7016 Anthracite grey, similar to RAL 7016	AG	154	730 145	204
 436-7003A	Anthrazitgrau, ähnlich RAL 7016 (glatt) Anthracite grey, similar to RAL 7016 (glossy)	AG	156	127	
 02.11.71.000039-116700 701205-167	Basaltgrau, ähnlich RAL 7012 Basalt grey, similar to RAL 7012	BG	183	158	
 02.11.71.000039-808300 701205-083	Basaltgrau, ähnlich RAL 7012 (glatt) Basalt grey, similar to RAL 7012 (glossy)	BG	173	126	
 02.11.71.000046-116700 703905-167	Quarzgrau, ähnlich RAL 7039 Quartz grey, similar to RAL 7039	QGR	538	537 545	
 02.11.71.000046-808300 703905-083	Quarzgrau, ähnlich RAL 7039 (glatt) Quartz grey, similar to RAL 7039 (glossy)	QGR	547	541	











Foliensortiment
Foil range

	Farbbezeichnung Colour description	Farbkürzel Colour ID			
 436-5038	Betongrau, ähnlich RAL 7023 Concrete grey, similar to RAL 7023	BGR	549	542	
 436-5045	Steingrau, ähnlich RAL 7030 Stone grey, similar to RAL 7030	STG	833	831	
 436-5031	Seidengrau, ähnlich RAL 7044 Silk grey, similar to RAL 7044	SEG	773	771	
 436-5033	Kieselgrau, ähnlich RAL 7032 Pebble grey, similar to RAL 7032	KG	666	664	
 436-1002	Metallic Silber Metallic silver	MS	528	701	
 02.11.71.000047-116700 715505-167	Silbergrau, ähnlich RAL 7001 Silver grey, similar to RAL 7001	SG	670	700 501	198
 02.11.71.000047-808300 715505-083	Silbergrau, ähnlich RAL 7001 (glatt) Silver grey, similar to RAL 7001 (glossy)	SG	179	125	
 02.11.71.000038-808300 700405-083	Signalgrau, ähnlich RAL 7004 (glatt) Signal grey, similar to RAL 7004 (glossy)	SI	178	124	
 436-1001	Aluminium gebürstet Brushed aluminium	ALG	517	702	













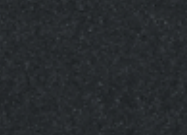



	Farbbezeichnung Colour description	Farbkürzel Colour ID			
 02.11.71.000045-808300 703805-083	Achatgrau, ähnlich RAL 7038 (glatt) Agate, similar to RAL 7038 (glossy)	AC	<input type="checkbox"/>516	<input type="checkbox"/>123	
 02.11.71.000049-116700	Lichtgrau, ähnlich RAL 7035 Light grey, similar to RAL 7035	LG	<input type="checkbox"/>188	<input type="checkbox"/>175	
 02.11.71.000049-808300 725105-083	Lichtgrau, ähnlich RAL 7035 (glatt) Light grey, similar to RAL 7035 (glossy)	LG	<input type="checkbox"/>182	<input type="checkbox"/>122	
 9.3167 011-116700 3167011-167	Eiche, natur Natural oak	EN	<input type="checkbox"/>536	<input type="checkbox"/>390	
 9.3167 002-116700 3167002-168	Eiche, hell Light oak	EH	<input type="checkbox"/>524	<input type="checkbox"/>400	<input type="checkbox"/>480
 9.3167 004-116700 3167004-167	Eiche, dunkel Dark oak	ED	<input type="checkbox"/>523	<input type="checkbox"/>570	<input type="checkbox"/>550
 49197	Montana Montana	MT	<input type="checkbox"/>529	<input type="checkbox"/>760	<input type="checkbox"/>197
 9.1192 001-116700 1192001-167	Oregon 4 Oregon 4	04	<input type="checkbox"/>532	<input type="checkbox"/>620	<input type="checkbox"/>199
 9.3069 041-116700 3069041-167	Bergkiefer Mountain pine	BK	<input type="checkbox"/>518	<input type="checkbox"/>630	<input type="checkbox"/>511



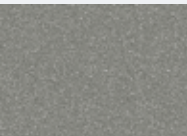





	Farbbezeichnung Colour description	Farbkürzel Colour ID			
 49198	Indian Indian	IN	<input type="checkbox"/>526	<input type="checkbox"/>770	<input type="checkbox"/>196
 49240	Winchester XA Winchester XA	WXA	<input type="checkbox"/>539	<input type="checkbox"/>703	
 9.3152 009-116700 3152009-167	Douglasie Douglas fir	DG	<input type="checkbox"/>522	<input type="checkbox"/>600	<input type="checkbox"/>490
 49195	Canadian Canadian	CA	<input type="checkbox"/>521	<input type="checkbox"/>780	<input type="checkbox"/>195
 49158	Golden Oak Golden oak	GO	<input type="checkbox"/>525	<input type="checkbox"/>610 <input type="checkbox"/>144	<input type="checkbox"/>470
 9.3162 002-116700	Macoré Macoré	MC	<input type="checkbox"/>527	<input type="checkbox"/>440	<input type="checkbox"/>544
 49233	Siena Rosso Siena rosso	SR	<input type="checkbox"/>535	<input type="checkbox"/>910 <input type="checkbox"/>504	<input type="checkbox"/>513
 49237	Siena Noce Siena noce	SN	<input type="checkbox"/>534	<input type="checkbox"/>900 <input type="checkbox"/>503	<input type="checkbox"/>512
 436-2048	Nussbaum Walnut	NB	<input type="checkbox"/>531	<input type="checkbox"/>460	

	Farbbezeichnung Colour description	Farbkürzel Colour ID			
 9.2097 013-116700 2097013-167	Mahagoni Mahogany	MA189580143560
 02.11.81.000101-116700 851805-167	Braun Dekor Brown woodgrain	BD519590205540
 456-5053	Reinweiß, ähnlich RAL 9010 Pure white, similar to RAL 9010	RW680750502	
 456-5054	Cremeweiß, ähnlich RAL 9001 Cream white, similar to RAL 9001	CW159646155141	
 456-5056	Hellelfenbein, ähnlich RAL 1015 Light ivory, similar to RAL 1015	EFB514174149	
 02.11.31.000013-116700 308105-167	Rot, ähnlich RAL 3011 Red, similar to RAL 3011	RT184870206530
 02.11.31.000012-116700 300505-167	Weinrot, ähnlich RAL 3005 Wine red, similar to RAL 3005	WR	171151	
 02.11.61.000013-116700 600505-167	Moosgrün, ähnlich RAL 6005 Moss green, similar to RAL 6005	MG176740505	
 436-5021	Tannengrün, ähnlich RAL 6009 Fir green, similar to RAL 6009	GN177890147510

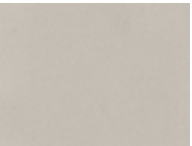
	Farbbezeichnung Colour description	Farbkürzel Colour ID			
 02.11.51.000028-116700 500705-167	Brilliantblau, ähnlich RAL 5007 Brilliant blue, similar to RAL 5007	BB	187	710	
 02.11.51.000033-116700 515005-167	Stahlblau, ähnlich RAL 5011 Steel blue, similar to RAL 5011	SB	185	830 146	500

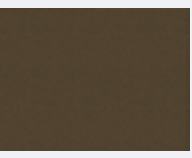
Schüco AutomotiveFinish ■ Schüco AutomotiveFinish

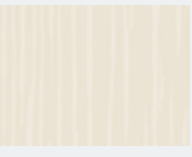
	Farbbezeichnung Colour description	Farbkürzel Colour ID			
	SAF-Metallic Black	MBL	314	621	
	SAF-DB 703 Line	DGL	313	619	
	SAF-DB 703 matt ■ Matt	DGM	301	601	
	SAF-RAL 9007 semigloss ■ Semi-gloss	GRM	303	603	
	SAF-RAL 9006 semigloss ■ Semi-gloss	SM	302	602	

	Farbbezeichnung Colour description	Farbkürzel Colour ID			
	SAF-Light Silver matt = Matt	LSM	<input type="checkbox"/>311	<input type="checkbox"/>614	
	SAF-White Line	PWS	<input type="checkbox"/>312	<input type="checkbox"/>612	
	SAF-RAL 140-M semigloss = Semi-gloss	GM	<input type="checkbox"/>306	<input type="checkbox"/>606	
	SAF-Deep Bronze matt = Matt	DBM	<input type="checkbox"/>309	<input type="checkbox"/>613	
	SAF-RAL 350-M semigloss = Semi-gloss	BNM	<input type="checkbox"/>308	<input type="checkbox"/>608	
	SAF-Cream Line	PBS			<input type="checkbox"/>611
	SAF-Copper Effect	BRS			<input type="checkbox"/>609